



POWERING INNOVATION THAT DRIVES HUMAN ADVANCEMENT

© 2025 ANSYS, Inc. or its affiliated companies  
Unauthorized use, distribution, or duplication is prohibited.

# Getting Started with HFSS™: Dielectric Resonator Antenna (DRA)



ANSYS, Inc.  
Southpointe  
2600 Ansys Drive  
Canonsburg, PA 15317  
[ansysinfo@ansys.com](mailto:ansysinfo@ansys.com)  
<https://www.ansys.com>  
(T) 724-746-3304  
(F) 724-514-9494

Release 2025 R1  
January 2025

ANSYS, Inc. and ANSYS  
Europe, Ltd. are UL registered  
ISO 9001:2015 companies.

## Copyright and Trademark Information

© 1986-2025 ANSYS, Inc. Unauthorized use, distribution or duplication is prohibited.

ANSYS, Ansys Workbench, AUTODYN, CFX, FLUENT and any and all ANSYS, Inc. brand, product, service and feature names, logos and slogans are registered trademarks or trademarks of ANSYS, Inc. or its subsidiaries located in the United States or other countries. Icem CFD is a trademark used by ANSYS, Inc. under license. All other brand, product, service and feature names or trademarks are the property of their respective owners. FLEXIm and FLEXnet are trademarks of Flexera Software LLC.

## Disclaimer Notice

THIS ANSYS SOFTWARE PRODUCT AND PROGRAM DOCUMENTATION INCLUDE TRADE SECRETS AND ARE CONFIDENTIAL AND PROPRIETARY PRODUCTS OF ANSYS, INC., ITS SUBSIDIARIES, OR LICENSORS. The software products and documentation are furnished by ANSYS, Inc., its subsidiaries, or affiliates under a software license agreement that contains provisions concerning non-disclosure, copying, length and nature of use, compliance with exporting laws, warranties, disclaimers, limitations of liability, and remedies, and other provisions. The software products and documentation may be used, disclosed, transferred, or copied only in accordance with the terms and conditions of that software license agreement.

ANSYS, Inc. and ANSYS Europe, Ltd. are UL registered ISO 9001: 2015 companies.

## U.S. Government Rights

For U.S. Government users, except as specifically granted by the ANSYS, Inc. software license agreement, the use, duplication, or disclosure by the United States Government is subject to restrictions stated in the ANSYS, Inc. software license agreement and FAR 12.212 (for non-DOD licenses).

## Third-Party Software

See the legal information in the product help files for the complete Legal Notice for Ansys proprietary software and third-party software. If you are unable to access the Legal Notice, please contact ANSYS, Inc.

## Conventions Used in this Guide

Please take a moment to review how instructions and other useful information are presented in this documentation.

- Procedures are presented as numbered lists. A single bullet indicates that the procedure has only one step.
- Bold type is used for the following:
  - Keyboard entries that should be typed in their entirety exactly as shown. For example, “**copy file1**” means you must type the word **copy**, then type a space, and then type **file1**.
  - On-screen prompts and messages, names of options and text boxes, and menu commands. Menu commands are often separated by greater than signs (>). For example, “click **HFSS > Excitations > Assign > Wave Port.**”
  - Labeled keys on the computer keyboard. For example, “Press **Enter**” means to press the key labeled **Enter**.
- Italic type is used for the following:
  - Emphasis.
  - The titles of publications.
  - Keyboard entries when a name or a variable must be typed in place of the words in italics. For example, “**copy filename**” means you must type the word **copy**, then type a space, and then type the name of the file.
- The plus sign (+) is used between keyboard keys to indicate that you should press the keys at the same time. For example, “Press Shift+F1” means to press the **Shift** key and, while holding it down, press the **F1** key also. You should always depress the modifier key or keys first (for example, Shift, Ctrl, Alt, or Ctrl+Shift), continue to hold it/them down, and then press the last key in the instruction.

**Accessing Commands:** *Ribbons*, *menu bars*, and *shortcut menus* are three methods that can be used to see what commands are available in the application.

- The *Ribbon* occupies the rectangular area at the top of the application window and contains multiple tabs. Each tab has relevant commands that are organized, grouped, and labeled. An example of a typical user interaction is as follows:

"Click **Draw > Line**"



This instruction means that you should click the **Line** command on the **Draw** ribbon tab. An image of the command icon, or a partial view of the ribbon, is often included with the instruction.

- The *menu bar* (located above the ribbon) is a group of the main commands of an application arranged by category such File, Edit, View, Project, etc. An example of a typical user interaction is as follows:

"On the **File** menu, click the **Open Examples** command" means you can click the **File** menu and then click **Open Examples** to launch the dialog box.

- Another alternative is to use the *shortcut menu* that appears when you click the right-mouse button. An example of a typical user interaction is as follows:

"Right-click and select **Assign Excitation > Wave Port**" means when you click the right-mouse button with an object face selected, you can execute the excitation commands from the shortcut menu (and the corresponding sub-menus).

### Getting Help: Ansys Technical Support

For information about Ansys Technical Support, go to the Ansys corporate Support website, <http://www.ansys.com/Support>. You can also contact your Ansys account manager in order to obtain this information.

All Ansys software files are ASCII text and can be sent conveniently by e-mail. When reporting difficulties, it is extremely helpful to include very specific information about what steps were taken or what stages the simulation reached, including software files as applicable. This allows more rapid and effective debugging.

### Help Menu

To access help from the Help menu, click **Help** and select from the menu:

- **[product name] Help** - opens the contents of the help. This help includes the help for the product and its *Getting Started Guides*.
- **[product name] Scripting Help** - opens the contents of the *Scripting Guide*.
- **[product name] Getting Started Guides** - opens a topic that contains links to Getting Started Guides in the help system.

### Context-Sensitive Help

To access help from the user interface, press **F1**. The help specific to the active product (design type) opens.

You can press **F1** while the cursor is pointing at a menu command or while a particular dialog box or dialog box tab is open. In this case, the help page associated with the command or open dialog box is displayed automatically.

# Table of Contents

<b>Table of Contents</b> .....	<b>Contents-1</b>
<b>1 - Introduction</b> .....	<b>1-1</b>
Finite Element Method .....	1-2
Overview of the Interface .....	1-3
<b>2 - Create the New Project</b> .....	<b>2-1</b>
Launch EDT and Insert an HFSS Design .....	2-1
Enable Legacy View Orientations .....	2-3
Set the Units of Measurement .....	2-5
Verify HFSS and Modeler Options .....	2-5
Select the Solution Type .....	2-8
<b>3 - Draw the Model</b> .....	<b>3-1</b>
Create the Spherical Cavity .....	3-1
Modify Cavity Attributes .....	3-4
Verify Lighting Attributes .....	3-6
Draw the Dielectric Resonator .....	3-8
Create the Annular Feed Ring .....	3-11
Draw the Feed Gap .....	3-15
Create the Air Volume .....	3-17
Split the Model for Symmetry .....	3-20
<b>4 - Setting Up the Problem</b> .....	<b>4-1</b>
Boundary Conditions .....	4-1
Assign a Radiation Boundary to the Air Volume .....	4-2
Assign a Perfect E Boundary to the Air Volume .....	4-4
Assign a Perfect H Boundary to the Annular Ring .....	4-6
Assign a Symmetry Boundary to the Model .....	4-7
Excitation Conditions .....	4-10
Assign a Lumped Port Across the Gap .....	4-10
Modify the Impedance Multiplier .....	4-14

Verify All Boundary and Excitation Assignments .....	4-15
<b>5 - Generating a Solution .....</b>	<b>5-1</b>
Add Solution Setup .....	5-1
Add a Frequency Sweep to the Solution Setup .....	5-3
Define Mesh Operations .....	5-5
Validate the Project Setup .....	5-6
Generate the Solution .....	5-7
View the Solution Data .....	5-9
View the Profile Data .....	5-9
View Convergence Data .....	5-11
View Matrix Data .....	5-12
View Mesh Statistics .....	5-14
<b>6 - Evaluating the Results .....</b>	<b>6-1</b>
Create an S-Parameters Report .....	6-1
Create a Z-Parameters Report .....	6-3
Create a Mag E Field Overlay Plot .....	6-5
Modify the Mag E Plot Attributes .....	6-8
Create a Phase Animation of the Mag E Plot .....	6-11
<b>7 - Optionally, Restore Current View Orientations .....</b>	<b>7-1</b>
<b>Index .....</b>	<b>Index-2</b>

# 1 - Introduction

This document is intended as supplementary material to HFSS for beginners and advanced users. It includes instructions to create, simulate, and analyze a dielectric resonator antenna.

## What You Will Learn

By following the steps in this guide, you will learn how to perform the following HFSS tasks in Ansys Electronics Desktop:

- Draw a geometric model
- Modify a model's design parameters
- Assign variables to a model's design parameters
- Specify solution settings for a design
- Validate a design's setup
- Run an HFSS simulation
- Create a 2D X-Y plot of S-parameter results
- Create a field overlay plot of results
- Create a phase animation of results

## Sample Project - Dielectric Resonator Antenna (DRA)

This antenna is cavity-backed with an annular-slot-fed hemispherical dielectric resonator. The antenna feed is achieved by coaxial excitation across one side of an annular slot between the cavity and the DRA dielectric. For this project, the engineering focus is on the behavior of the antenna itself, not its feed. Therefore, the model will feed with a lumped port across an annular slot. The design's operating frequency is 3.5 GHz.

### Note:

This project is also described and analyzed in the following IEEE publication:

- Leung, K.W., So, K.K., "Annular-slot-Excited Dielectric Resonator Antenna with a Backing Cavity," *IEEE Transactions on Antennas and Propagation*, August 2002.

A half-symmetry model of a Dielectric Resonator Antenna (DRA), designed in Ansys Electronics Desktop as an HFSS design, is illustrated in the following figure:

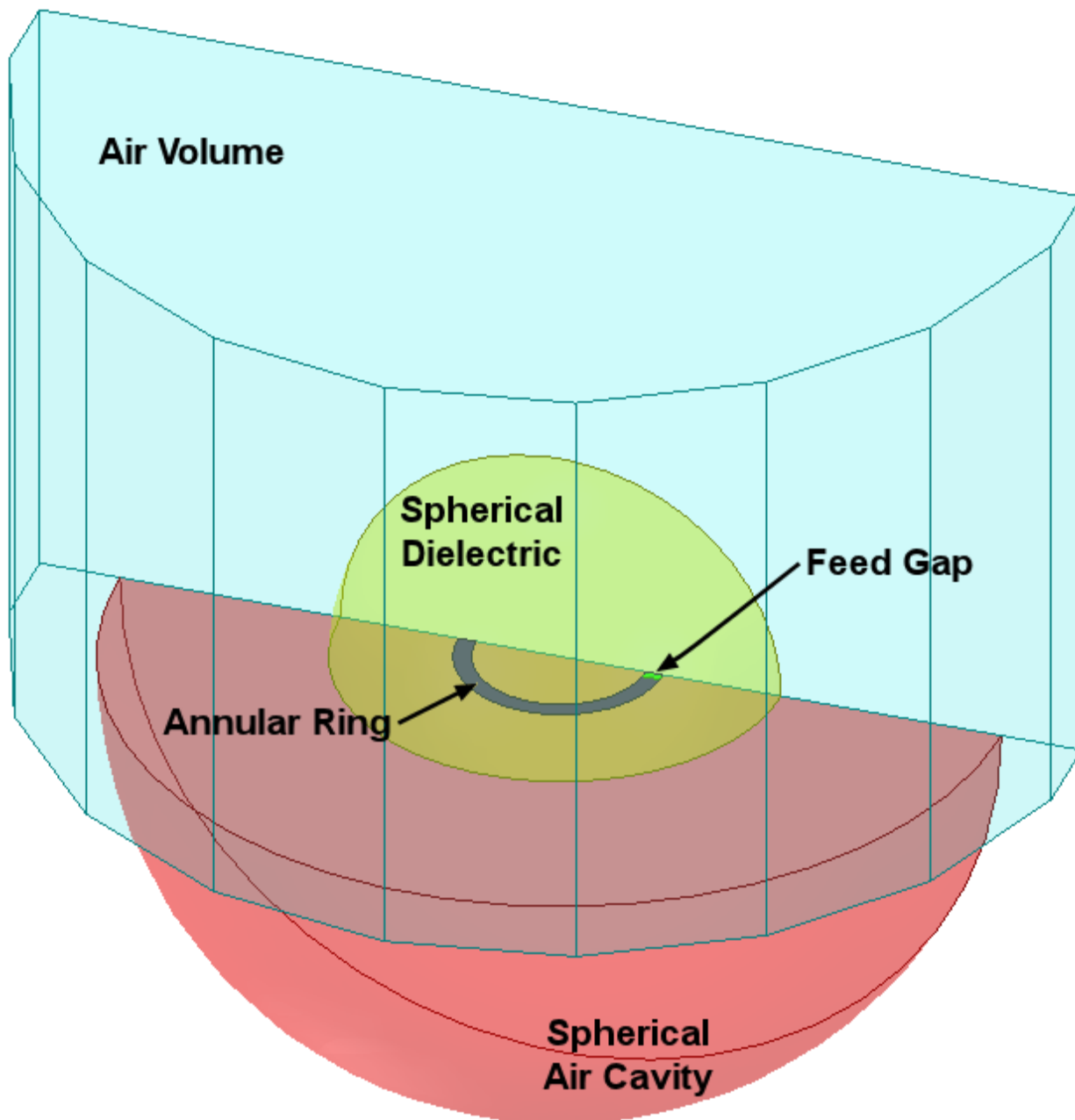

Figure 1-1: Sample Project - Dielectric Resonator Antenna (DRA)

## Finite Element Method

The geometry for the DRA described in this document appears in the following figure.

In HFSS, the model is automatically divided into a large number of tetrahedra. A tetrahedron is a four-sided polyhedron with planar faces that are all triangular (also referred to as a triangular pyramid). Unlike the pyramids of Egypt, the base is triangular, not rectangular, and there is one

fewer side. This collection of tetrahedra is referred to as the *finite element mesh*. The figure below shows the automatically created mesh for the DRA.

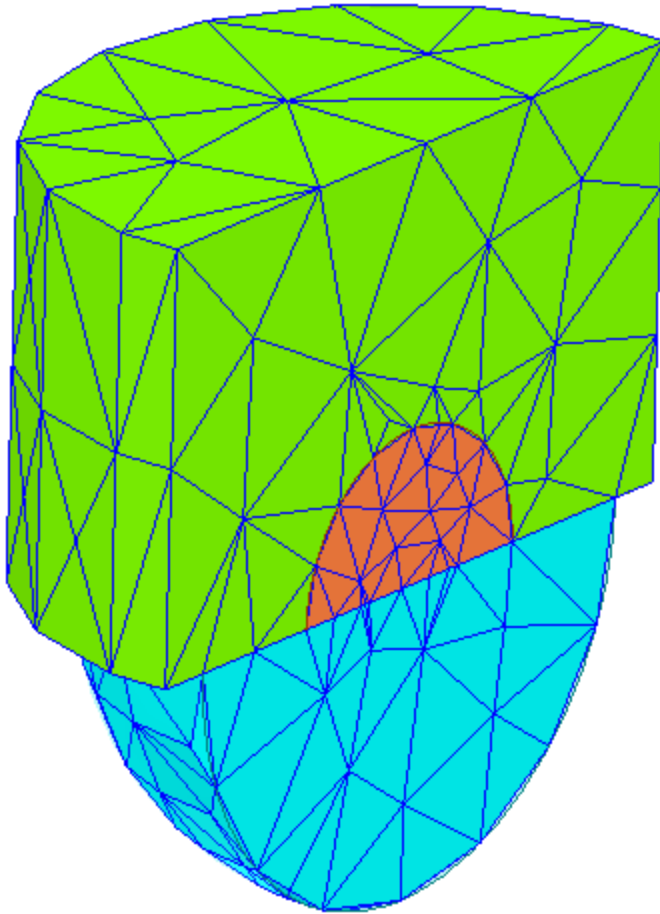

**Figure 1-2: The Mesh that Constitutes the Antenna**

Dividing a structure into thousands of smaller, basic regions (elements) allows the system to compute the field solution separately in each element. The computations at each individual element are relatively simple, but together, the elements can represent a complex and otherwise unsolvable structure. Generally, the smaller the system makes the elements, the more accurate the final solution will be. The quality of the elements (aspect ratio, internal angles, and so on) is also a consideration.

## Overview of the Interface

This section provides an overview of the HFSS user interface. The following figure represents an HFSS design of a dielectric resonator antenna within the Ansys Electronics Desktop.

# Getting Started with HFSS™: Dielectric Resonator Antenna (DRA)

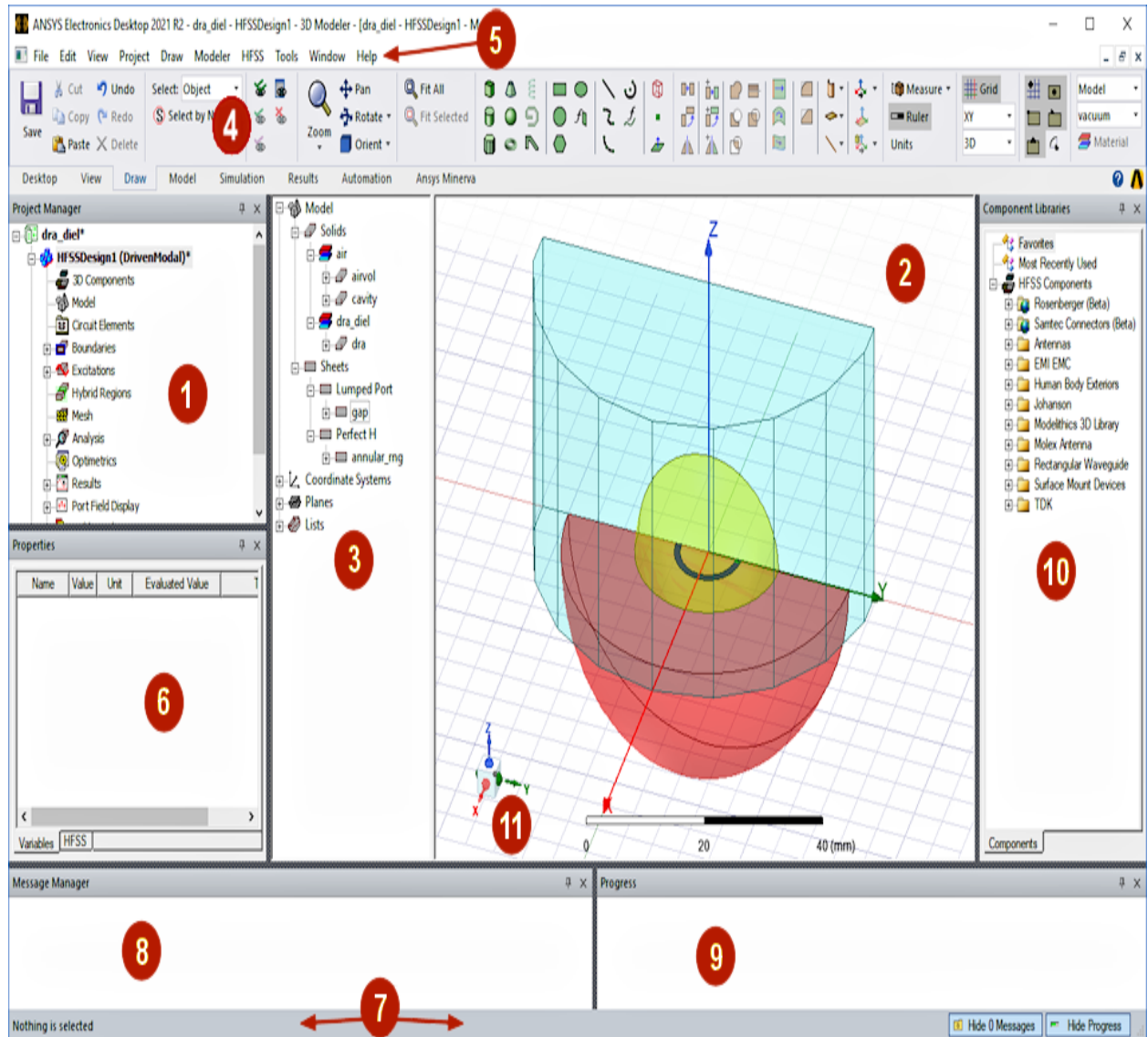

**Figure 1-3: Overview of the Ansys Electronics Desktop Graphical User Interface**

The following table describes the different options present in the user interface:

<b>1</b>	<b><i>Project Manager Window</i></b>	Displays details of the design projects. Each project has its own main branch of the project tree, which ultimately includes various information and options (like the type of design, boundaries and excitations, analysis setups, and analysis results).
----------	--------------------------------------	--

<b>2</b>	<b>Modeler Window</b>	Includes the drawing area of the active model and the <i>History Tree</i> (item 3).
<b>3</b>	<b>History Tree</b>	Displays all operations and commands carried out on the active model (such as information about the model's objects, all actions associated with each object, and coordinate system information).
<b>4</b>	<b>Ribbon</b>	<p>Contains various commands and options to create, manage, set up, analyze, and evaluate your designs and to customize program options. These commands and options are organized into related sets, with each logical group on a separate tab. The ordering of the tabs is designed to follow a left-to-right workflow. Certain popular commands (such as <i>Save</i> and various <i>View</i> options) appear on multiple tabs.</p> <p>Not all of the available commands can be accessed via the ribbon. Others are accessed from the <i>Menu Bar</i> (item 5) and shortcut menus that appear when you right-click.</p>
<b>5</b>	<b>Menu Bar</b>	Provides various menus that enable you to perform all of the HFSS tasks (such as managing project files, customizing the desktop components, drawing objects, and setting and modifying all project parameters).
<b>6</b>	<b>Properties Window</b>	<p>Displays the attributes of a selected object in the active model (such as the object's name, material assignment, orientation, color, and transparency). This window also displays information about a selected command that has been carried out. For example, if a circle was drawn, the information about the command includes its name (<i>CreateCircle</i>), the type and name of the coordinate system the circle was drawn in, the coordinates of the circle's center position, its axis, and its radius.</p> <p>To differentiate this window from the similar <i>Properties</i> dialog box, it is typically referred to as the "docked <i>Properties</i> window" within the Getting Started Guides.</p>

7	<b>Status Bar</b>	Shows current actions and provides instructions.  Also, depending on the command being carried out, the status bar can display the X, Y, and Z coordinate boxes; the <b>Absolute/Relative</b> drop-down menu to choose whether to enter a point's absolute or relative coordinates; a drop-down menu to specify points in Cartesian, Cylindrical, or Spherical coordinates; and the active model's unit setting.
8	<b>Message Manager Window</b>	Displays errors, warnings, and informational messages for an active project.
9	<b>Progress Window</b>	Displays solution progress information.
10	<b>Component Libraries Window</b>	This window is one of several that you can optionally display or hide via the <b>View</b> menu. It displays 3D components that are stored in the SysLib and PersonalLib directories. From here you can easily add 3D components into your project.  Other windows you can display here contain <i>Components</i> , <i>Layers</i> , and <i>Nets</i> information. Additionally, the <i>ACT Extensions</i> window (supported on Windows platforms only) has wizards to automate the creation of various models.
11	<b>Orientation Gadget</b>	This gadget is a graphical tool for quickly and easily manipulating the view orientation.

## 2 - Create the New Project

This chapter contains the following topics:

- Launch the application and insert an HFSS design
- Enable legacy view orientations
- Set the units of measurement
- Verify HFSS and modeler options
- Select the solution type
- Set the coordinate system

### Launch EDT and Insert an HFSS Design

Launch the Ansys Electronics Desktop application and insert an HFSS Design in which to create the dielectric resonator antenna (DRA). There are several procedures to complete prior to beginning model construction.

#### Launch Ansys Electronics Desktop (EDT):

For convenience, a shortcut to the EDT application is placed on your desktop during program installation. Optionally, you may want to pin the shortcut to your Windows Start Menu too.

1. Double-click  **Ansys Electronics Desktop** (or click the same shortcut on your Start Menu) to launch the application.

Ansys Electronics Desktop opens.

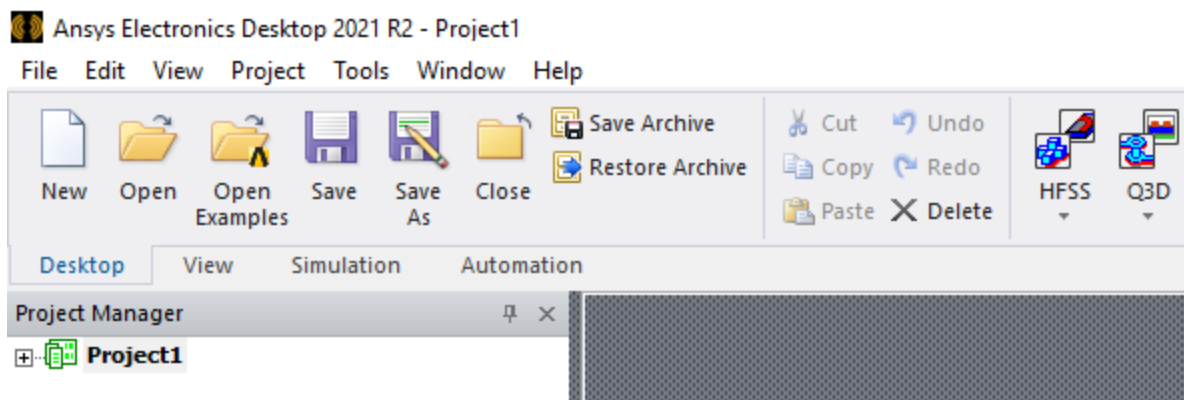



Figure 2-1: Ansys EDT Application Launched

**Note:**

If a project is not listed at the top of the Project Manager, click  **New** on the **Desktop** ribbon tab to include one. If the *Project Manager* window does not appear after launching the application, go to the **View** menu and select the **Project Manager** option.

**Insert an HFSS Design:**

2. On the **Desktop** ribbon tab, click  **Insert HFSS Design**.

**HFSSDesignx** appears in the Project Manager. Click **+** to expand the branch.

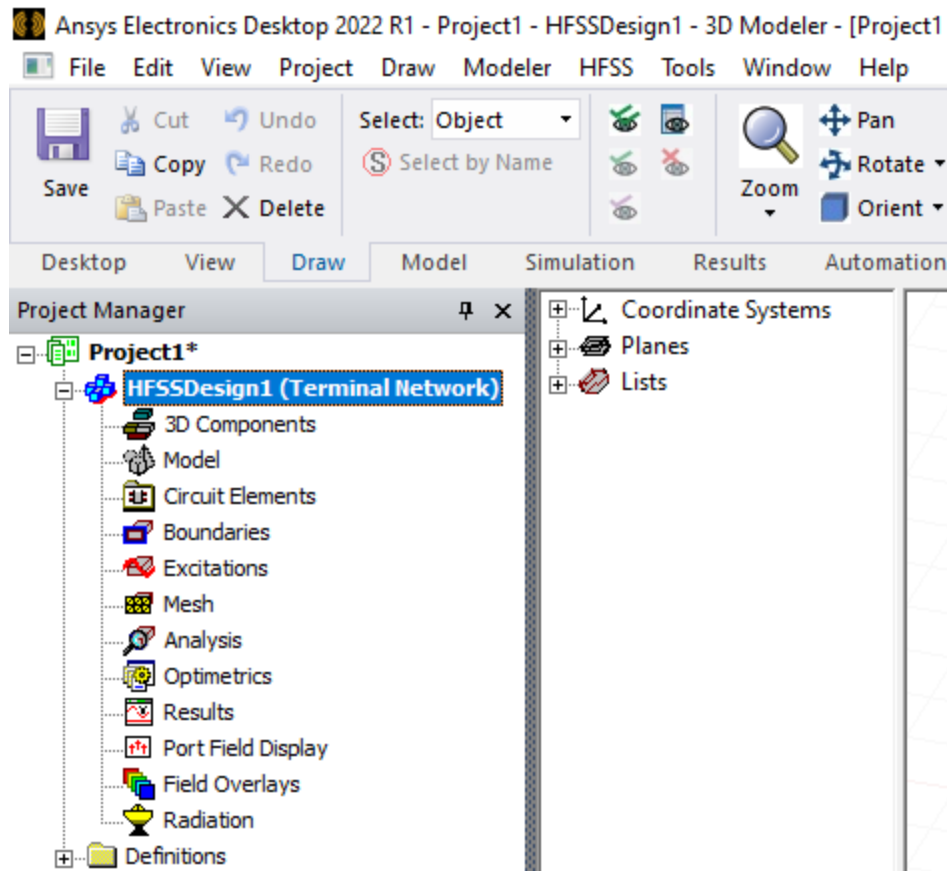

**Figure 2-2: HFSSDesignx Inserted**

**Note:**

The *Definitions* folder includes materials, scripts, and other data stored under the project name.

3. On the **Desktop** ribbon tab, click  **Save As**.

The *Save As* dialog box appears.

4. Browse for a location to store the file (such as D:\MyProjects), and then double-click the folder's name. You can also create a new folder through this dialog box.
5. Type **DRA** in the **File name** text box and then click **Save**.

This operation saves the project in the specified location with the file extension *aedt*. Notice that the project name at the top of the Project Manager has been updated too.

## Enable Legacy View Orientations

This getting started guide was created based on standard view orientations that were in effect for version 2023 R2 and earlier of the Ansys Electronics Desktop application. For consistency between your experience and the views and instructions contained in this guide, select the *Enable Legacy View Orientation* option in the 3D UI Options dialog box, as follows:

1. From the menu bar, click **View > Options**.

The *3D UI Options* dialog box appears.

2. Select **Enable Legacy View Orientation**:

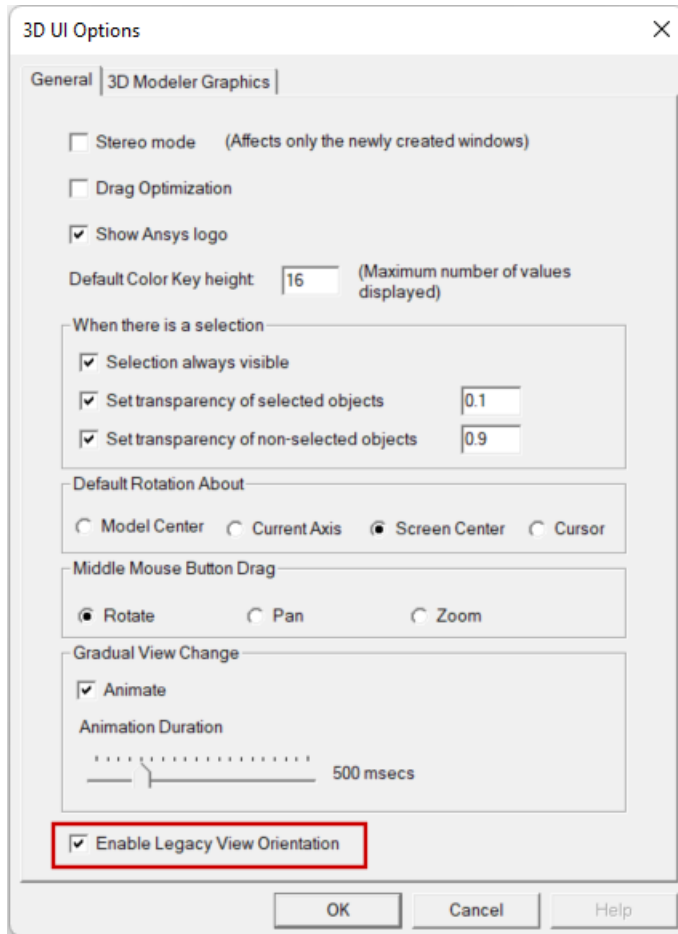

3. Click **OK**.

Changing the view orientation option does not change the model viewpoint that was in effect at the time.

4. On the **Draw** ribbon tab, click  **Orient** to change to the *Trimetric* view, which is the default legacy view orientation.

You do not have to select *Trimetric* from the *Orient* drop-down menu. The default view appears when you click *Orient*.

Although this option can only be accessed once a design is added to a project, it is a global option. Your choice is retained for all future program sessions, projects, and design types that use the 3D Modeler or that produce 3D plots of results.

At the end of this guide, you will be prompted to clear the *Enable Legacy View Orientation* option, if you prefer to use the view orientation scheme implemented for 2024 R1 and newer versions going forward.

For a comparison of the legacy and current view orientations, search for "*View Options: 3D UI Options*" in the HFSS help. Additionally, views associated with **Alt + double-click** zones have

been redefined. The current orientations are shown in the help topic, "*Changing the Model View with Alt+Double-Click Areas.*"

## Set the Units of Measurement

Set the units of measurement for drawing the geometric model to millimeters, as follows:

1. On **Draw** ribbon tab, click **Units**.

The *Set Model Units and Max Extent* dialog box appears.

2. Select **mm** (millimeters) from the **Select units** drop-down menu if it is not already selected.

Keep the **Rescale to new units** and **Advanced** options cleared.

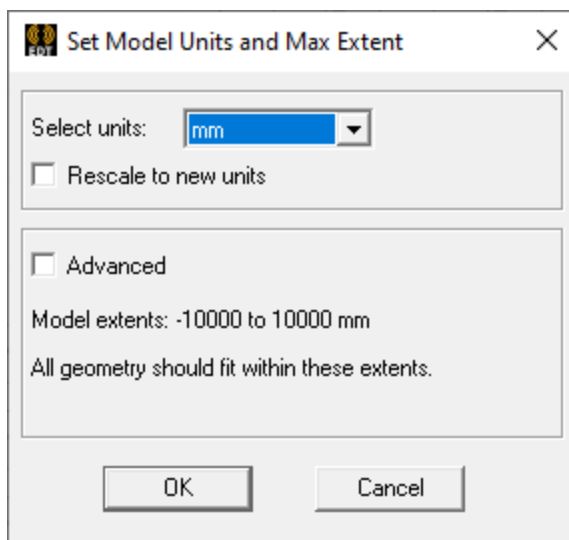



Figure 2-3: *Set Model Units* Dialog Box

3. Click **OK**.

## Verify HFSS and Modeler Options

Verify the relevant general options, as follows:

1. On the **Desktop** ribbon tab, click  **General Options**.

The *Options* dialog box appears.

2. In the options tree, expand the **HFSS** branch and select **Boundary Assignment**.
3. Ensure all *Boundary Assignment* options are selected, as shown below:

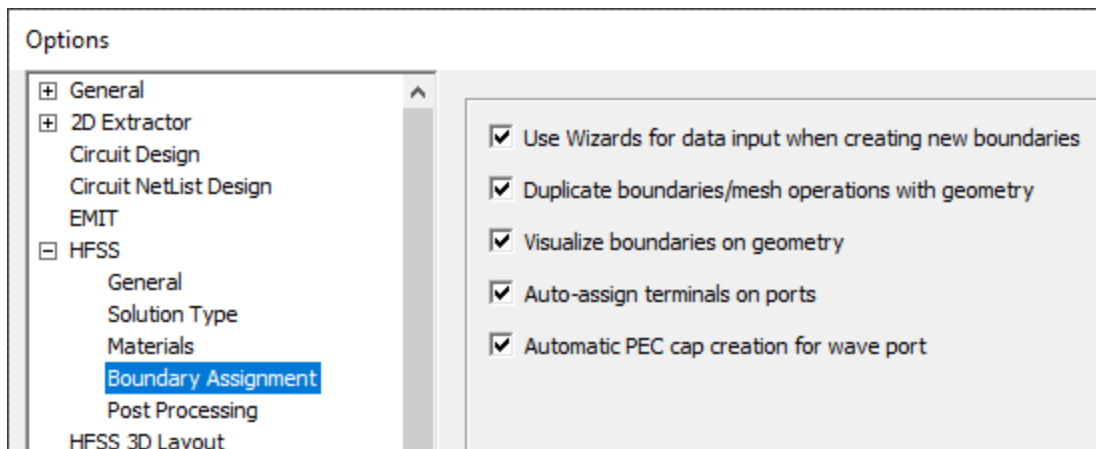
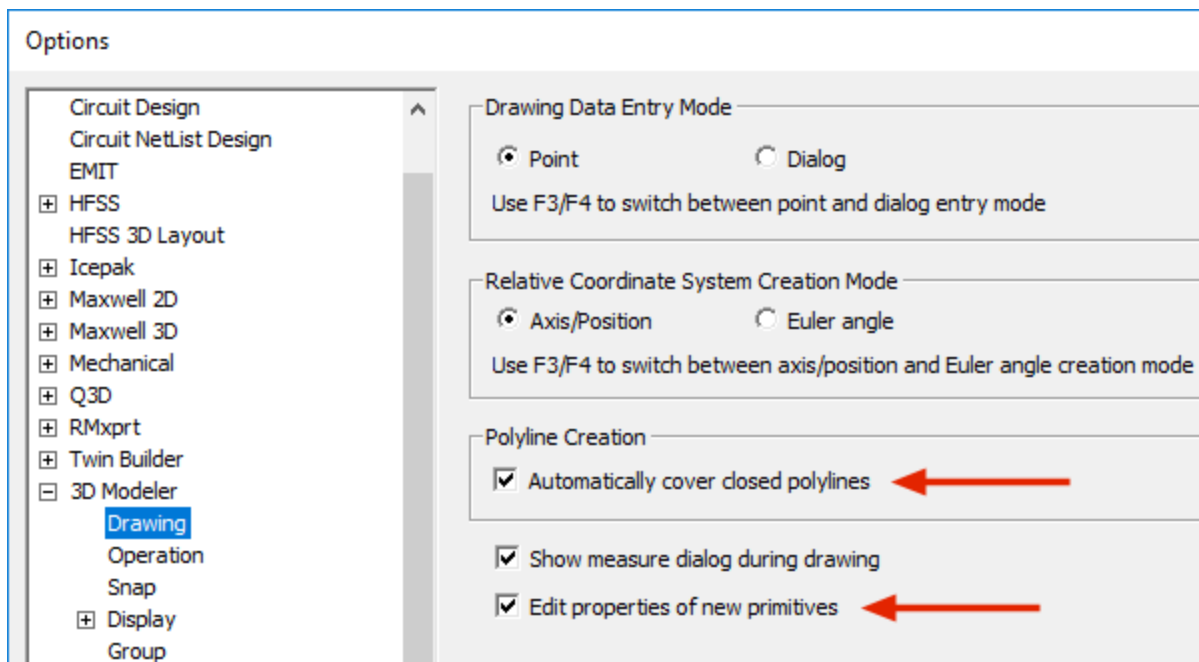

**Figure 2-4: Options Dialog Box – HFSS > Boundary Assignment Group**

4. In the options tree, expand the **3D Modeler Options** branch and select **Drawing**.
5. Ensure that the following two options are selected, as shown in the figure below:
  - **Automatically cover closed polylines**
  - **Edit properties of new primitives**

**Note:**

This option causes a *Properties* dialog box to appear when you create a new primitive/object.



**Figure 2-5: Options Dialog Box – 3D Modeler > Drawing Group**

6. In the options tree, select **3D Modeler > Operation**.
7. In the *Clone* section, select **Clone tool objects before intersecting**.

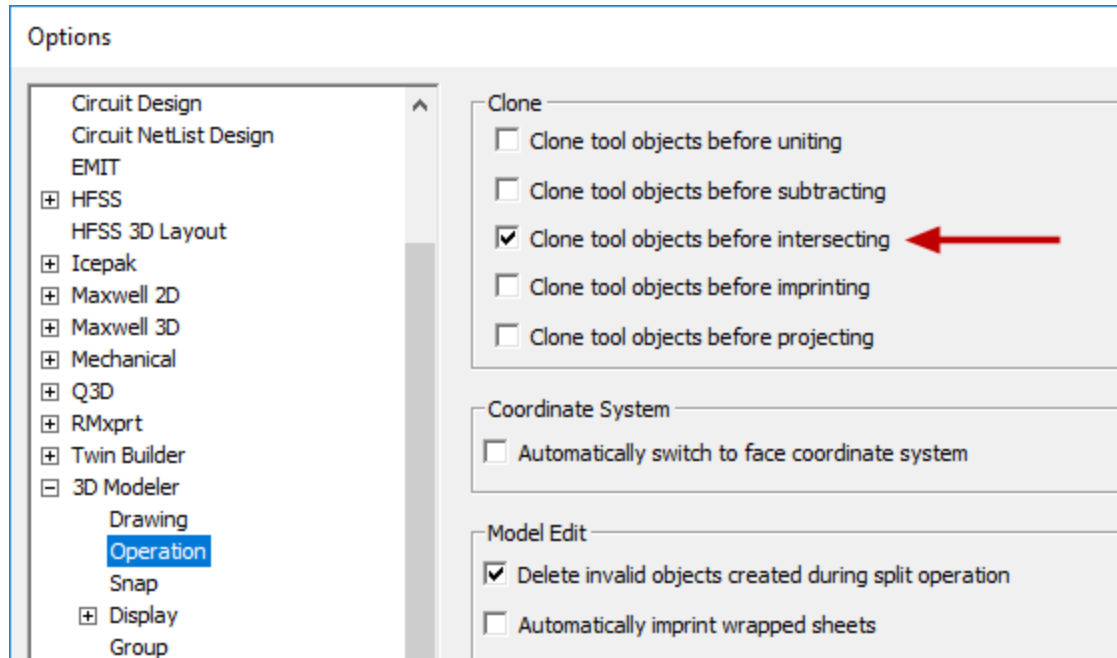
**Figure 2-6: Options Dialog Box – 3D Modeler > Operation Group****Note:**

This option instructs the 3D Modeler to always keep a copy of the first item selected when that object is intersected with one or more other objects.

8. Click **OK**.

**Grid Settings**

The grid displayed in the *Modeler* window is a drawing aid to visualize the location of objects and to draw objects to prescribed size increments. The cursor snaps to grid point by default when you click the mouse while drawing objects. The points on the grid are divided by their local x-, y-, and z-coordinates, and grid spacing is set according to the current project's drawing units.

For this antenna project, you do not need to edit any of the grid's default properties.

**Note:**

To edit the grid properties, click the **View** menu and select **Grid Settings**. The *Grid Spacing* dialog box appears. Use this dialog box to control the grid type (Cartesian or polar), style (dots or lines), density, spacing, or visibility.

## Select the Solution Type

To set the solution type:

1. From the menu bar, click **HFSS > Solution Type**.

The *Solution Type* dialog box opens.

2. Under *Options*, select **Modal** and also ensure that the remaining settings are as shown in the following image:

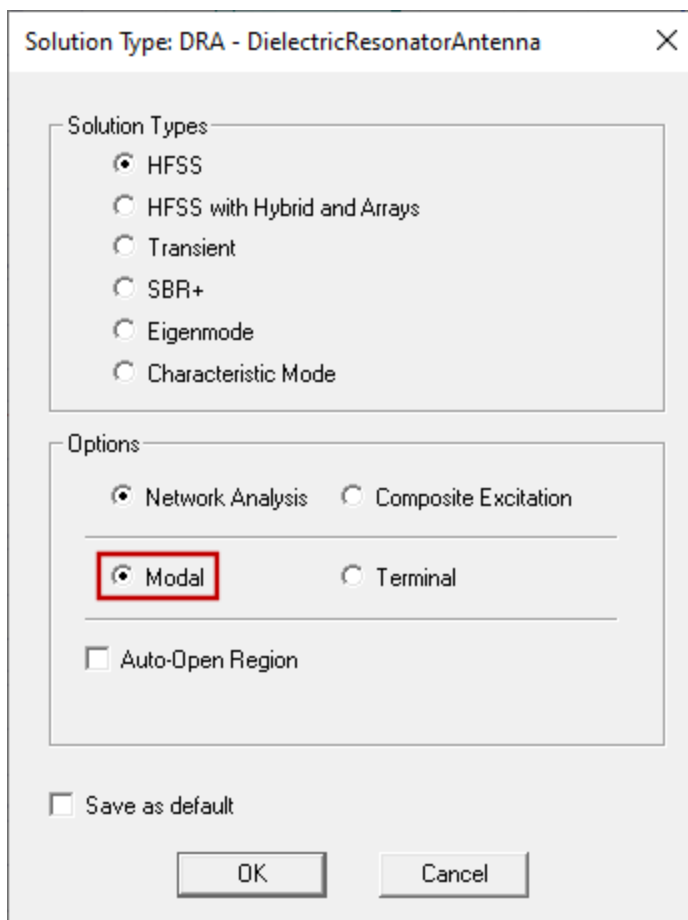

**Figure 2-7: Solution Type Dialog Box**

**Note:**

Since this antenna project is a mode-based problem, *Modal* is the appropriate solution type option.

3. Click **OK**.

At this point you can start drawing the antenna geometry.

**Set the Coordinate System**

For this antenna problem, use the *Global* coordinate system (CS) as the working CS. This coordinate system is fixed and is active by default. You can create other coordinate systems to facilitate orienting new objects. The available CS types are summarized in the table below:

<b>Global CS</b>	The fixed, default CS for each new project.
<b>Relative CS</b>	A user-defined CS. Its origin and orientation can be set relative to the global CS, relative to another <b>Relative CS</b> , or relative to a geometric feature. This type of CS enables you to easily draw objects that are located relative to other objects.
<b>Face CS</b>	A user-defined CS. Its origin is specified on a planar object face. This type of CS enables you to easily draw objects that are located against another object's face.

## 3 - Draw the Model

This chapter contains the following topics:

- Create the Spherical Cavity
  - Modify the Cavity Attributes
  - Verify Lighting Attributes
- Draw the Dielectric Resonator
- Create the Annular Feed Ring
- Draw the Feed Gap
- Create the Air Volume
- Split the Model for Symmetry

### DRA Geometry:

The dielectric resonator antenna (DRA) model consists of five basic objects, with parameters as listed in the table below:

<b>Air Volume</b>	30 mm radius and a height of 35 mm
<b>Spherical Cavity</b>	25 mm radius
<b>Spherical Dielectric</b>	12.5 mm radius
<b>Annular Ring</b>	5.8 mm outer radius and a width of 1.0 mm.
<b>Feed Gap</b>	1 mm thickness

#### Note:

All objects are centered at the global origin (0, 0, 0).

### Create the Spherical Cavity

In order to create the antenna's spherical cavity, first draw a sphere and then split it to generate a hemispherical solid. The steps are listed below.

1. On the **Draw** ribbon tab, click  **Draw sphere**.
2. Draw a sphere with the global origin as its center and with a radius = 25mm, as follows:

- a. Click on the **Global Origin**. The cursor becomes a black diamond to indicate snapping points at the origin and all other grid points.
- b. Press **Tab** to jump into the **dX** text box at the bottom of the EDT window. Specify the following coordinates to define the *Radius* and then press **Enter**:

**dX: 25, dY: 0, dZ: 0**

**Note:**

Use the **Tab** key to navigate through the *dX*, *dY*, and *dZ* text boxes.

The sphere appears in the drawing region, and the *Properties* dialog box appears:

	Name	Value	Unit	Evaluated Value
Command	CreateSphere			
Coordinate Sys...	Global			
Center Position	0,0,0		mm	0mm, 0mm, 0mm
Radius	25		mm	25mm

**Figure 3-1: Sphere Properties – Command Tab**

3. Ensure that the values in the **Command** tab of the *Properties* dialog box match the preceding figure.
4. In the **Attribute** tab of the *Properties* dialog box, change the object **Name** to **Cavity**.
5. Deselect **Material Appearance**, if it's currently selected, to use your default object color and transparency settings rather than those specified in the materials library.
6. Click **OK** to close the *Properties* dialog box.

For now, keep the sphere selected.

7. Press **Ctrl+D** to fit the sphere within the drawing region.

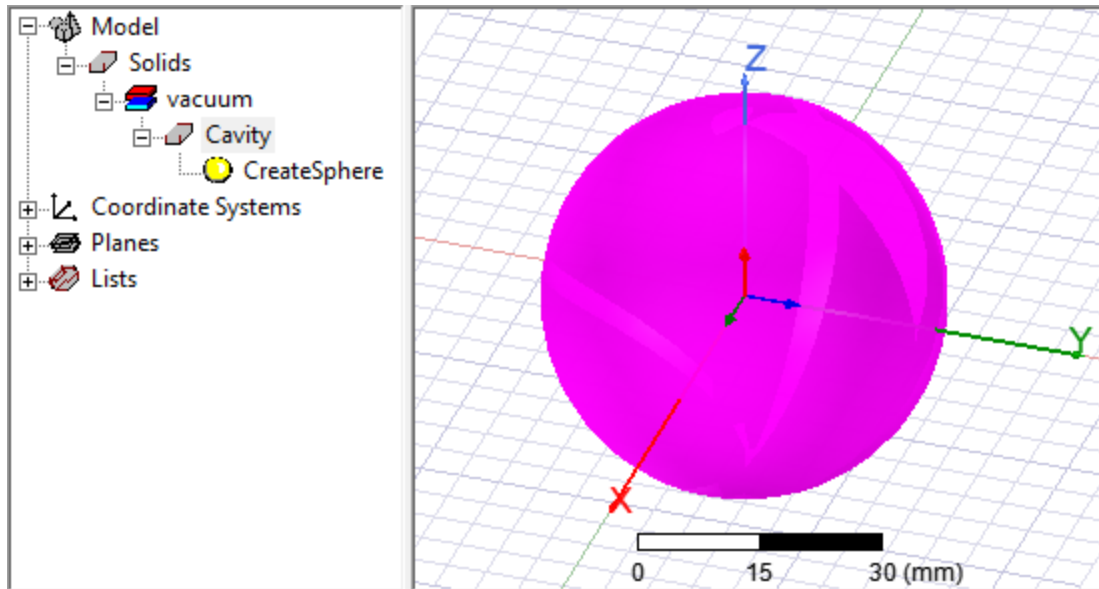



Figure 3-2: Sphere and History Tree in the *Modeler* Window

8. On the **Draw** ribbon tab, click  **Split**.  
The *Split* dialog box appears.
9. Set all options on the *Split* dialog box as shown in the following figure and then click **OK**:

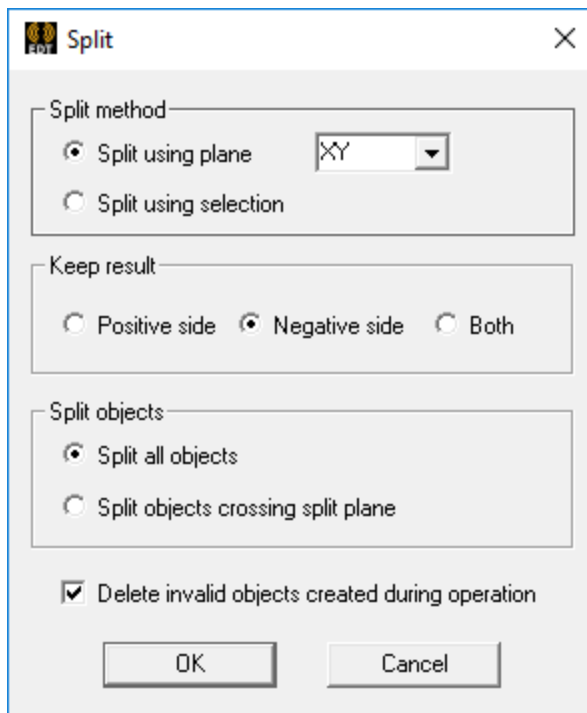
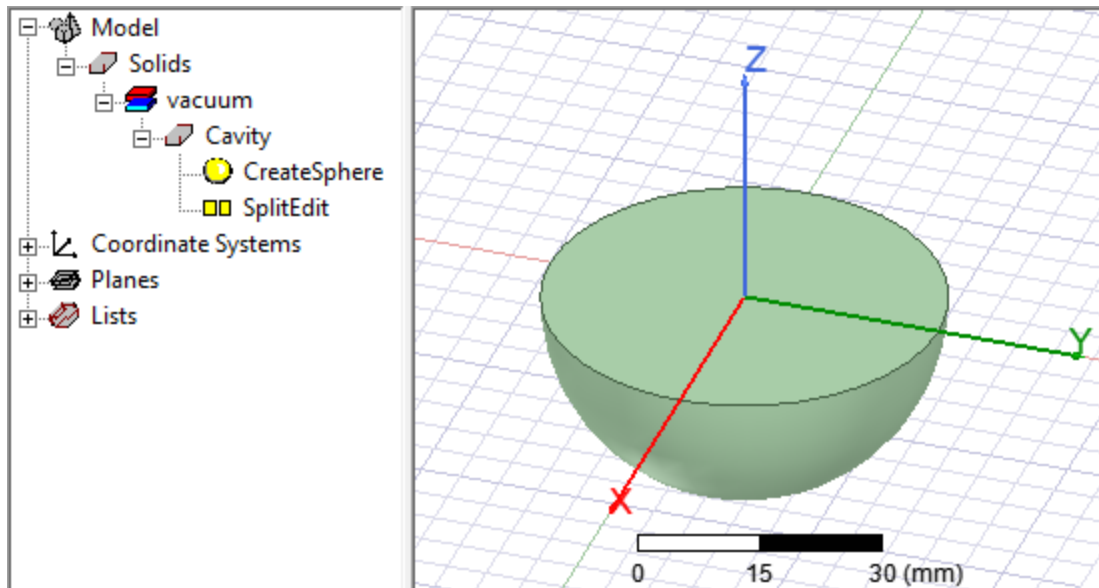

Figure 3-3: *Split* Dialog Box for *Cavity*

The object *Cavity* is split, and only the negative half of the sphere remains.

10. Click in the Modeler window's background area to clear the current selection.

The color and transparency of your sphere may differ from the following image (depending on your default appearance settings):



**Figure 3-4: Cavity after Splitting**

## Modify Cavity Attributes

On this page, you will learn about an alternative method of modifying the attributes of the Cavity object (other than the *Properties* dialog box used in the last page).

1. Click **Cavity** in the History Tree to display its attributes in the docked *Properties* window.

### Note:

You can enable this window by selecting **View > Properties** from the menu bar, if it is not currently displayed.

Attribute				
	Name	Value	Unit	Evaluated Value
	Name	Cavity		
	Material	"vacuum"		"vacuum"
	Solve Inside	<input checked="" type="checkbox"/>		
	Orientation	Global		
	Model	<input checked="" type="checkbox"/>		
	Group	Model		
	Display Wireframe	<input type="checkbox"/>		
	Material Appearance	<input type="checkbox"/>		
	Color			
	Transparent	0.4		

**Figure 3-5: Cavity Attributes**

2. Ensure that the selected **Material** is "**vacuum**", which is the initial default material for a new HFSS design.

In the previous procedure, you ensured that the *Material Appearance* option was cleared. In addition to assigning default color and transparency attributes, having this option cleared enables you to override the default material appearance.

3. Click the color bar in the *Value* column of the **Color** row.

The *Color* palette appears.

4. Select **red** (row 2, column 1 of the predefined colors), as shown below:

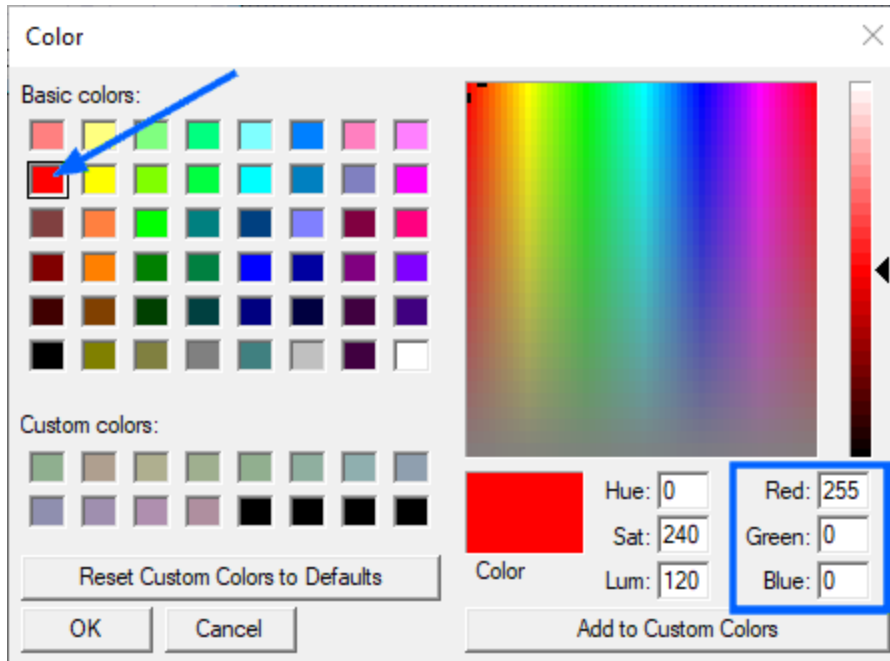

**Figure 3-6: Color Palette**

Verify that the RGB values are **Red: 255, Green: 0, Blue: 0** and then click **OK**.

- Click the button in the *Value* column of the **Transparent** row.

The *Set Transparency* dialog box appears.

- Enter **0.7** for the value of **Transparency**, as shown below, and click **OK**:

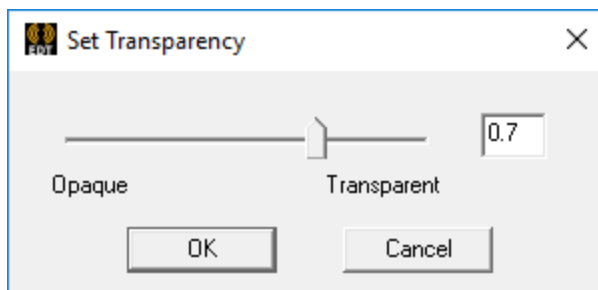

**Figure 3-7: Set Transparency Dialog Box**

- Click outside the object, on the Modeler window background, to deselect *Cavity*.

The object now has a translucent red appearance.

## Verify Lighting Attributes

- From the far right end of the **View** ribbon tab, click **Modify Attributes > Lighting**.

The *Lighting Properties* dialog box appears.

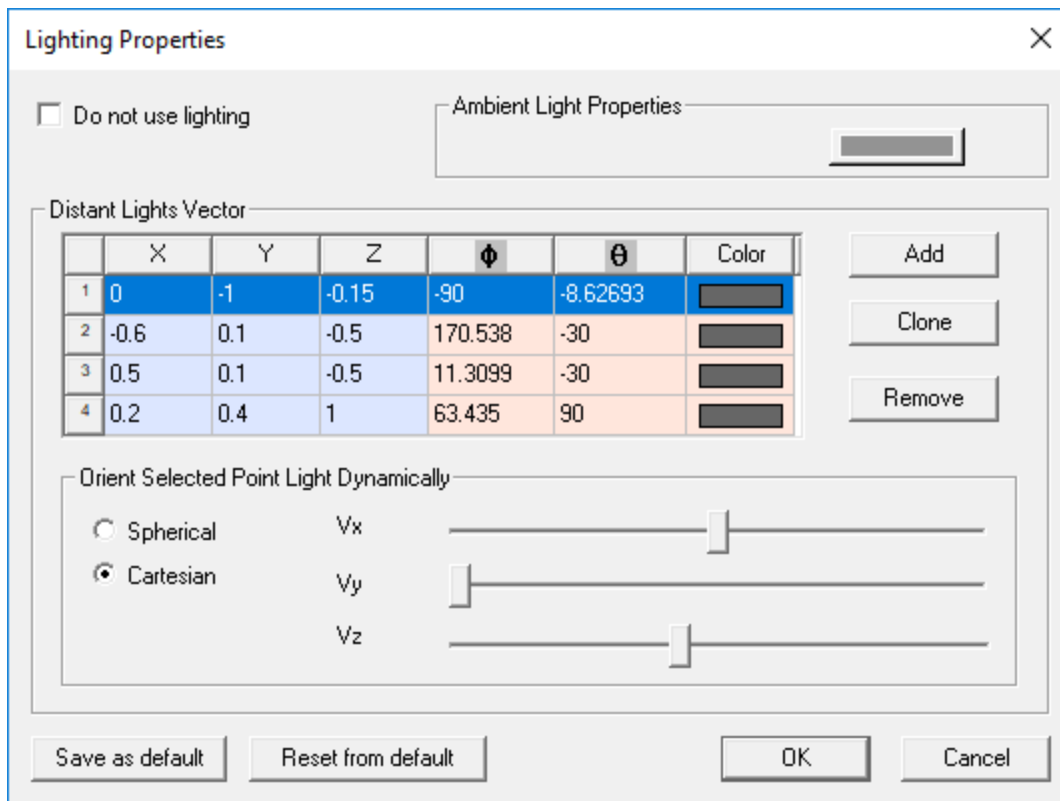

**Figure 3-8: Lighting Properties Dialog Box**

2. Verify that the **Do not use lighting** option is **cleared** (*not* selected).

You can keep the remaining settings at their default values.

3. Click **OK**.

Your completed *Cavity* object should resemble the figure below:

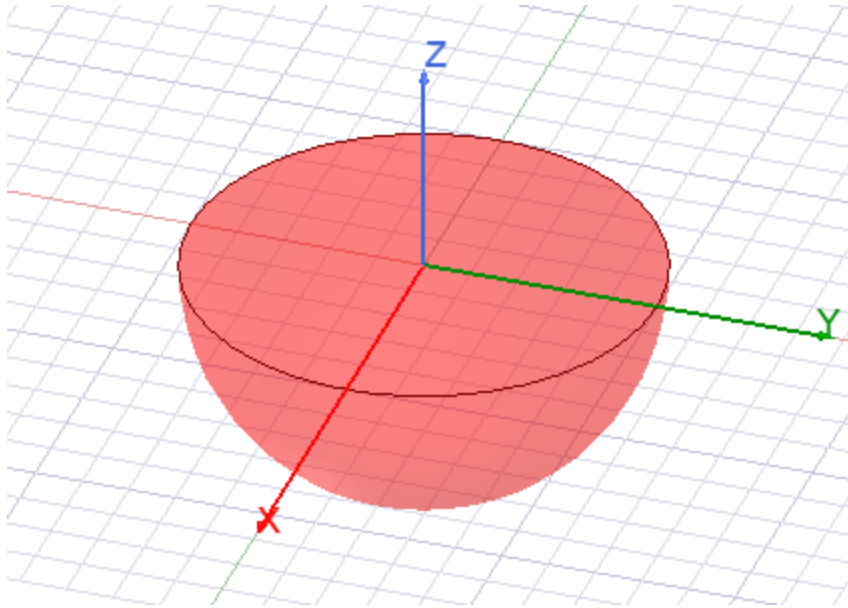
Figure 3-9: The *Cavity* with Attribute Changes Applied

## Draw the Dielectric Resonator

Now, draw another sphere, edit its attributes, and split it.

1. On the **Draw** ribbon tab, click  **Draw sphere**.
2. Draw a sphere with its center at the origin and radius = 12.5 mm.
3. Ensure that the settings in the **Command** tab of the *Properties* dialog box match the following figure:

Command		Attribute			
	Name	Value	Unit	Evaluated Value	
	Command	CreateSphere			
	Coordinate Sys...	Global			
	Center Position	0 , 0 , 0	mm	0mm , 0mm , 0mm	
	Radius	12.5	mm	12.5mm	

Figure 3-10: Properties for dra

4. Click the **Attribute** tab and type **Dielectric** in the **Name** text box.
5. From the **Material** drop-down menu, choose **Edit**.

The *Select Definition* dialog box appears.

6. Click **Add Material**.

The *View / Edit Material* dialog box appears.

7. Specify the new material properties as follows:
  - a. In the **Material Name** text box, type **dra\_diel**.
  - b. In the **Value** column of the **Relative Permittivity** row, specify **9.5**.

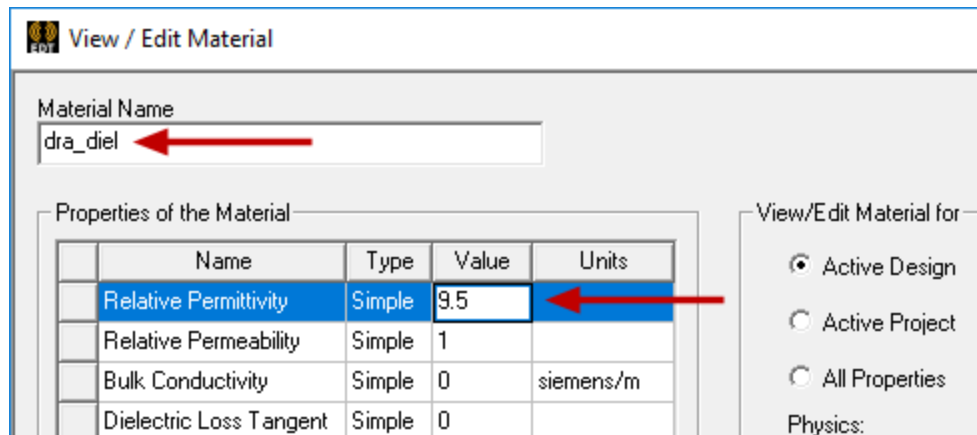

**Figure 3-11: View / Edit Material Dialog Box – Dielectric Material Properties**

- c. Click **OK** twice to close the *View / Edit Materials* and *Select Definition* dialog boxes.
8. Ensure that the **Material Appearance** option is **not selected**.
9. Change the **Color** to **yellow** (row 2, column 2 of the predefined palette colors: *Red: 255, Green: 255, Blue: 0*).
10. Set the **Transparent** value at **0.7**.
11. Click **OK** but keep the *Dielectric* object selected for now.

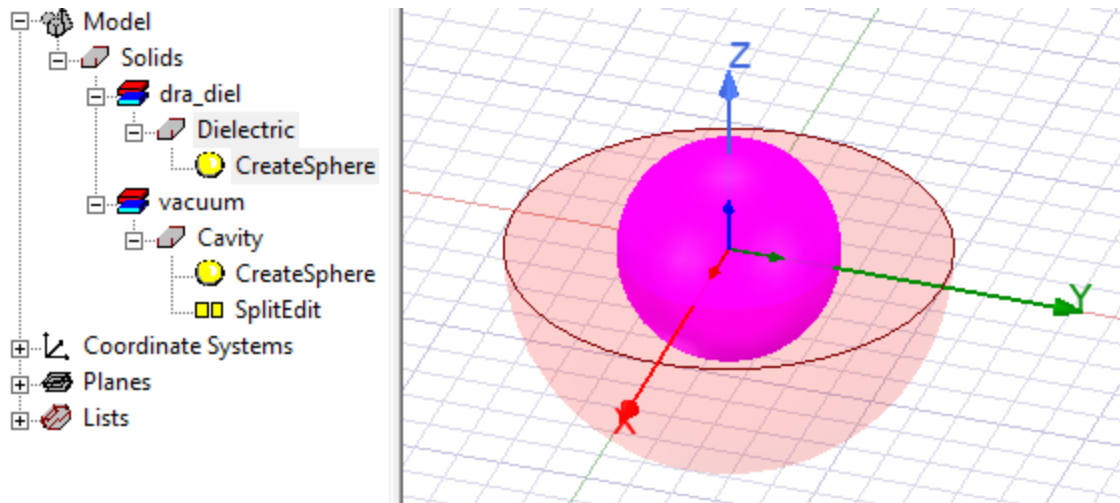

**Figure 3-12: The Dielectric Object Added**

12. On the **Draw** ribbon tab, click **Split**.

The *Split* dialog box appears.

13. Set all options on the *Split* dialog box as shown in the following figure and then click **OK**:



**Figure 3-13: *Split* Dialog Box for *Dielectric***

The object *Dielectric* is split into a hemispherical solid. Only the positive half of the original sphere has been retained.

14. Clear the current selection. You model should look like the following figure:

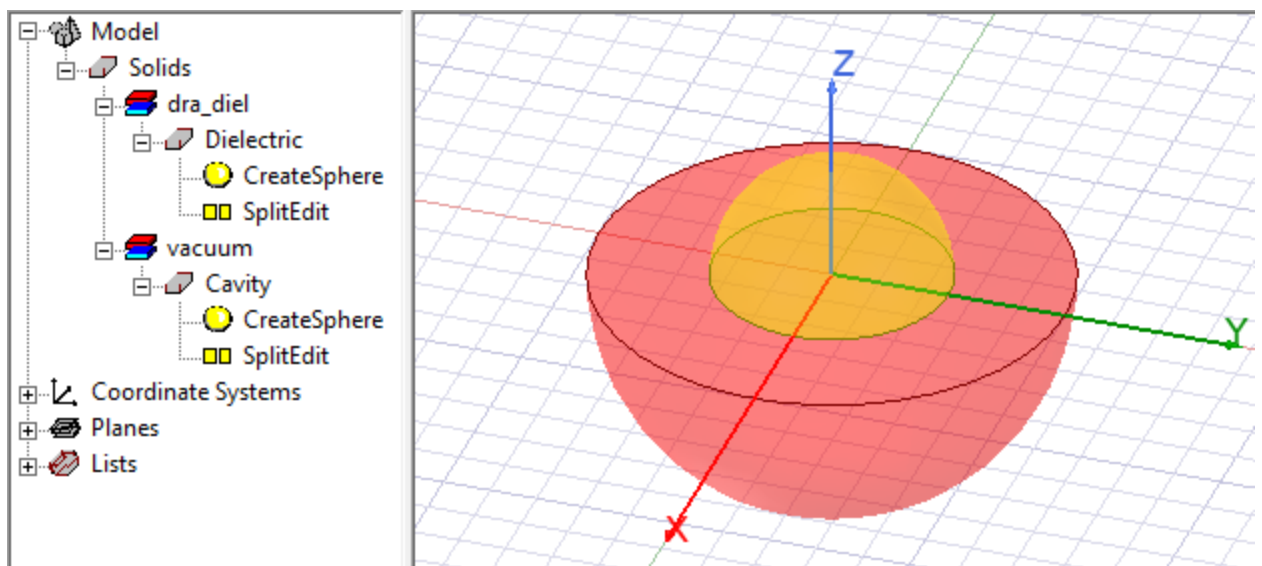



Figure 3-14: *Dielectric* after Splitting

## Create the Annular Feed Ring

In this antenna model, the annular feed ring is the controlled aperture through which the E-fields will radiate. Later on in the project, you will assign a perfect H boundary to the annular feed ring to allow the E-fields to radiate through it. In this procedure, you will create the antenna's annular feed ring, which is the result of subtracting one circle from another. You will also specify the attributes of the new object.

### Draw the Outside Circle:

1. On the **Draw** ribbon tab, click  **Draw circle**.
  - a. Click the **global origin** to indicate the center point. The cursor will become a filled circle at the proper snapping point, since this point is the center of the two hemispherical objects previously drawn.
  - b. Enter the following values in the coordinate text boxes at the bottom of the EDT window:
    - **dX: 5.8**
    - **dY: 0**
    - **dZ: 0**
  - c. Press **Enter**.

In the *Properties* dialog box that appears, verify that the properties under the **Command** tab are as shown below:

Command		Attribute		
	Name	Value	Unit	Evaluated Value
	Command	CreateCircle		
	Coordinate Sys...	Global		
	Center Position	0 ,0 ,0	mm	0mm , 0mm , 0mm
	Axis	Z		
	Radius	5.8	mm	5.8mm
	Number of Seg...	0		0

Figure 3-15: Outside Circle Properties – *Command* Tab

**Note:**

Alternatively, you could have drawn a random circle and then edited its location and radius in the *Command* tab of the *Properties* dialog box.

2. On the **Attribute** tab of the *Properties* dialog box, change the object **Name** to **AnnularRing**.

**Note:**

The object is not yet an annular ring, but it will be soon. Editing the attributes now is more efficient than reselecting the finished ring later and editing the attributes at that time.

3. Ensure that the **Material Appearance** option is **not selected**.
4. Change the object **Color** to **dark blue** (row 5, column 5 of the predefined colors; *Red: 0, Green: 0, Blue: 128*).
5. Set the **Transparent** to **0.5**.
6. Click **OK** to close the *Properties* dialog box.

The outside circle of the annular feed ring has been added to the model and is currently selected:

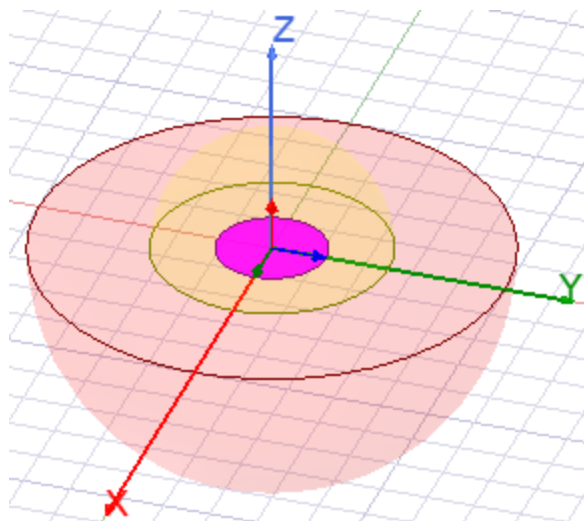

**Figure 3-16: Annular Feed Ring's Outside Circle Added to Model**

## Draw the Inside Circle:

7. On the **Draw** ribbon tab, click  **Draw circle**.
  - a. Click the **global origin** to indicate the center point. The cursor will become a filled circle at the proper snapping point, since this point is the center of the two hemispherical objects and the previously drawn circle.
  - b. Enter the following values in the coordinate text boxes at the bottom of the EDT window:
    - **dX: 4.8**
    - **dY: 0**
    - **dZ: 0**
  - c. Press **Enter**.

In the *Properties* dialog box that appears, verify that the settings under the **Command** tab are as shown below:

Command		Attribute		
	Name	Value	Unit	Evaluated Value
	Command	CreateCircle		
	Coordinate Sys...	Global		
	Center Position	0,0,0	mm	0mm, 0mm, 0mm
	Axis	Z		
	Radius	4.8	mm	4.8mm
	Number of Seg...	0		0

**Figure 3-17: Inside Circle Properties – Command Tab**

8. On the **Attribute** tab of the *Properties* dialog box, change the object **Name** to **ID\_Circle**.

**Note:**

Because you renamed the first circle *AnnularRing*, the second circle was automatically named *Circle1* instead of *Circle2*. Renaming it to *ID\_Circle* helps to avoid confusion.

9. Click **OK** to close the *Properties* dialog box.

### **Subtract *ID\_Circle* from *AnnularRing*:**

10. In the History Tree, click **AnnularRing** to select it.
11. Holding **Ctrl**, click **ID\_Circle** to select it also.
12. In the **Draw** ribbon tab, click  **Subtract**.

13. In the *Subtract* dialog box that appears, verify that the settings are as shown below and then click **OK**.

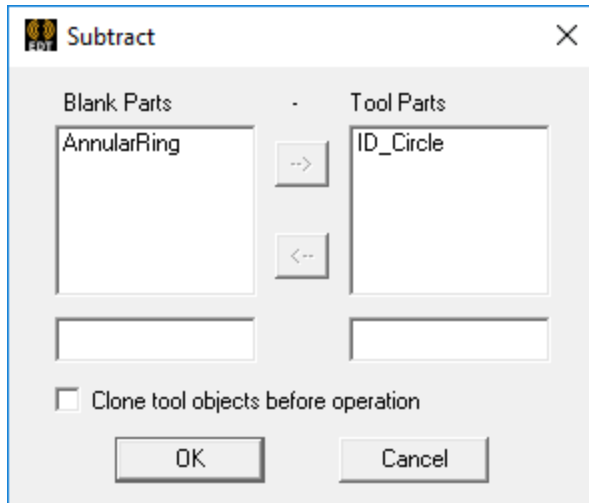

**Figure 3-18: Subtract Dialog Box**

*ID\_Circle* is subtracted from *AnnularRing*, and the resulting object is an actual annular ring now.

**Note:**

The selection order determines which object is the *Blank Part* and which is the *Tool Part*. However, you can move objects from one list to the other as needed before performing the operation.

14. Clear the current selection.

You model should resemble the following figure:

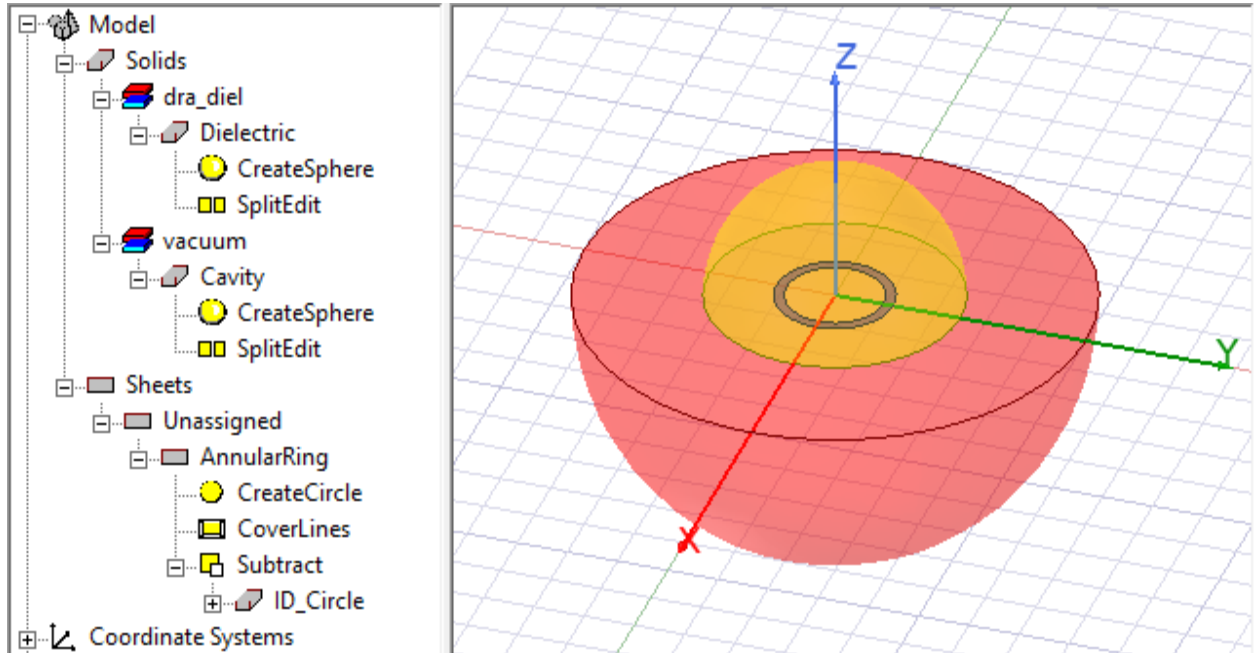



Figure 3-19: *AnnularRing* Completed

## Draw the Feed Gap

The feed gap is the object through which the excitation is fed. You will first draw a rectangle that extends through the annular feed ring. You will then intersect the ring and rectangle to reduce the gap to only the area where the two objects overlap each other.

### Draw the Gap Rectangle:

1. On the **Draw** ribbon tab, click  **Draw rectangle**.
2. Click anywhere on the grid, move the mouse, and click again to draw a rectangle of any arbitrary size and location.

As soon as you click the second point, the *Properties* dialog box appears.

3. On the **Command** tab of the *Properties* dialog box, specify the **Position**, **XSize**, and **YSize** values, as shown in the following figure:

Command		Attribute		
Name	Value	Unit	Evaluated Value	
Command	CreateRectangle			
Coordinate Sys...	Global			
Position	-0.5 ,0 ,0	mm	-0.5mm , 0mm , ...	
Axis	Z			
XSize	1	mm	1mm	
YSize	10	mm	10mm	

Figure 3-20: Rectangle Properties – Command Tab

4. On the **Attribute** tab of the *Properties* dialog box, change the object **Name** to **Gap**.
5. Ensure that the **Material Appearance** option is **not selected**.
6. Change the object **Color** to **green** (row 3, column 3 of the predefined colors; *Red: 0, Green: 255, Blue: 0*).
7. Set the **Transparent** value to **0** (opaque).
8. Click **OK** and then clear the current selection.

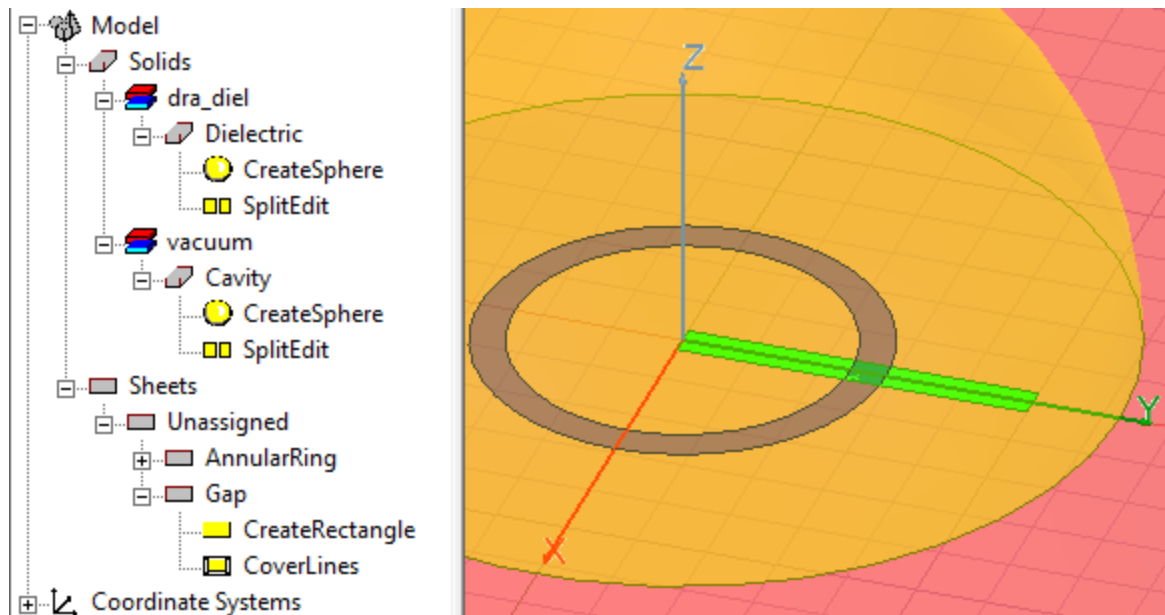

Figure 3-21: The Gap Rectangle Drawn

## Intersect the Gap Rectangle and Annular Feed Ring:

9. In the History Tree, select **Gap**.
10. Hold down **Ctrl** and also select **AnnularRing**.

**Note:**

The selection order of these two objects is critical.

11. On the **Draw** ribbon tab, click  **Intersect**.

The rectangle is trimmed to the two circles comprising the annular feed ring, forming the completed *Gap* object. The extraneous portions of the feed rectangle are removed, and the object *AnnularRing* remains.

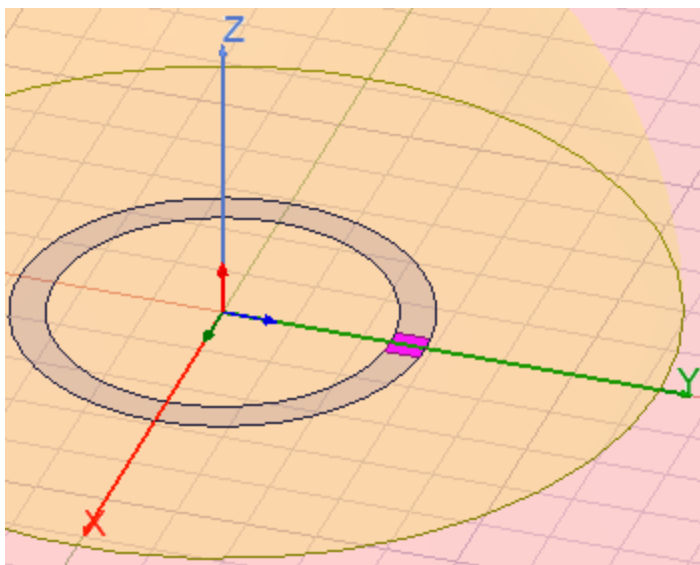

**Figure 3-22: Feed Gap Completed**

The selection order determines which object is cloned and retained after the intersection operation (specifically, the first item selected).

**Note:**

If the *AnnularRing* object is not retained after the operation, recheck the **General Options** in the **3D Modeler > Operation** group per the [relevant instructions on the Verify HFSS and Modeler Options page](#).

## Create the Air Volume

To analyze radiation effects, create a virtual object that represents the radiation boundary. A box-shaped area (rectangular prism) can also be created automatically, which is demonstrated in other exercises. For this antenna model, you will manually create a radiation-transparent air volume surface sufficiently far from the model. The shape will be an 18-sided regular polygon

approximating a cylinder. The start position coordinates will be 30, 0, 0 mm and the height 35 mm.

**Note:**

The segmented quasi-cylindrical shape can help to produce a somewhat better quality or more consistent mesh as compared to a smooth curved surface. Segmented *planar* shapes are also very useful for visualizing the twist resulting from sweeping a face into a solid when you specify a non-zero twist angle.

1. On the **Draw** ribbon tab, click  **Draw regular polyhedron**.
2. Click the global origin (cursor turns to sphere at snapping point) to define the center of the polygon base.
3. Click on two more randomly chosen points to set the initial diameter and height of the polygon.

The *Segment number* dialog box appears as soon as you click for the third time.

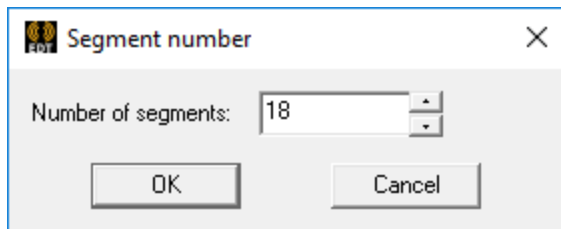

**Figure 3-23: Segment Number Dialog Box**

4. Set **Number of Segments** to **18** and click **OK**.

The *Properties* dialog box appears.

5. In the **Command** tab of the *Properties* dialog box, enter the values as shown in the following figure:

Command		Attribute		
	Name	Value	Unit	Evaluated Value
	Command	CreateRegularPolyhedron		
	Coordinate System	Global		
	Center Position	0 ,0 ,0	mm	0mm , 0mm , 0mm
	Start Position	30 ,0 ,0	mm	30mm , 0mm , 0mm
	Axis	Z		
	Height	35	mm	35mm
	Number of Segments	18		18

Figure 3-24: Polyhedron Properties – *Command Tab*

6. In the **Attribute** tab of the *Properties* dialog box, change the **Name** from Polyhedron1 to **AirVolume**.
7. Set the **Material** to "air" as follows:  
 Choose **Select** from the **Material** drop-down menu, select "air" from the *Select Definition* dialog box, and click **OK** to return to the *Properties* dialog box.
8. Ensure that the **Material Appearance** option is **not selected**.
9. Specify a *bright blue-green* **Color** (row 2, column 5 of the predefined palette colors; *Red: 0, Green: 255, Blue: 255*).
10. Set **Transparent** to **0.9**.
11. Click **OK** to accept the settings and close the *Properties* dialog box.
12. Press **Ctrl+D** if needed to fit the model to the display area and clear the current selection to view the resulting color and transparency assignments.

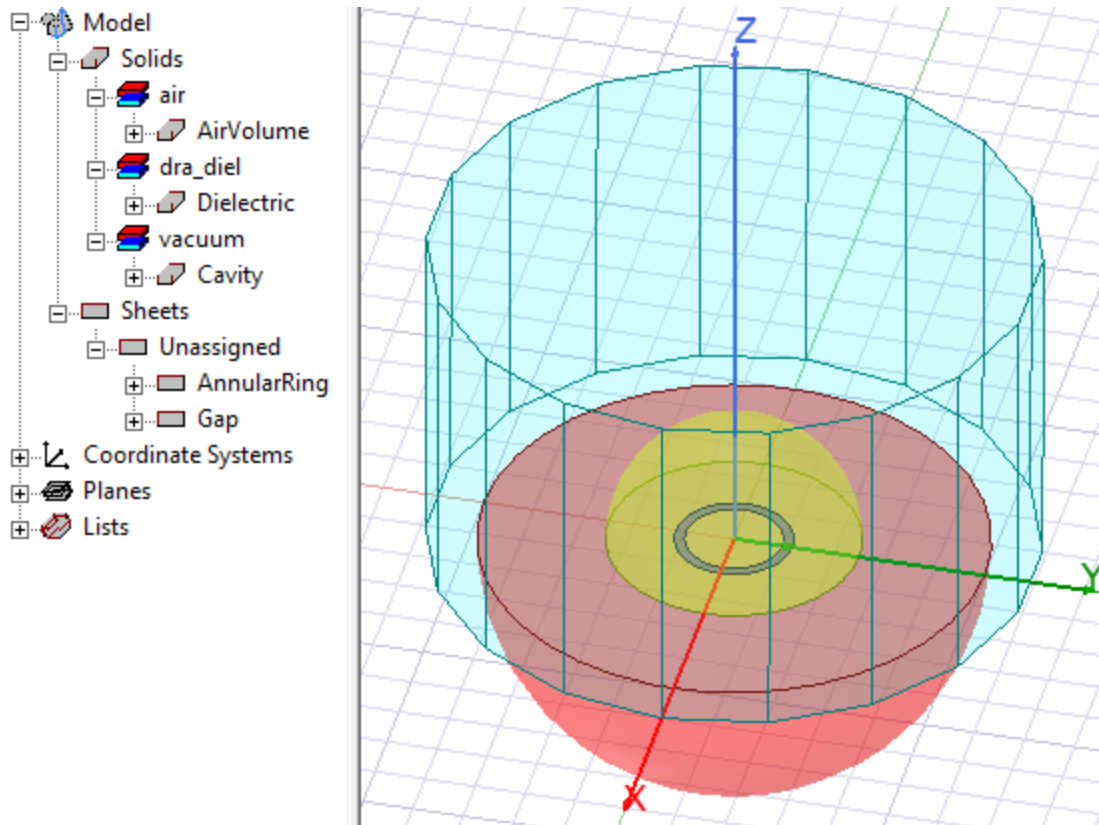

Figure 3-25: Air Volume Completed

13.  **Save** the project.

## Split the Model for Symmetry

This model, as constructed, is symmetrical about the YZ plane. Split the model along this plane to take advantage of symmetry. The volume of the model is cut in half and, therefore, the number of elements. The end result is a model that produces equally valid results but in a shorter time and while consuming significantly less of the computer resources (that is, memory and hard disk space).

1. Press **Ctrl+A** to select all objects in the model.

Alternatively, you can use the menu bar (**Edit > Select All**).

2. On the **Draw** ribbon tab, click  **Split**.

The *Split* dialog box appears.

3. Select **YZ** from the **Split using plane** drop-down menu and **Positive side** as the **Keep result** option:

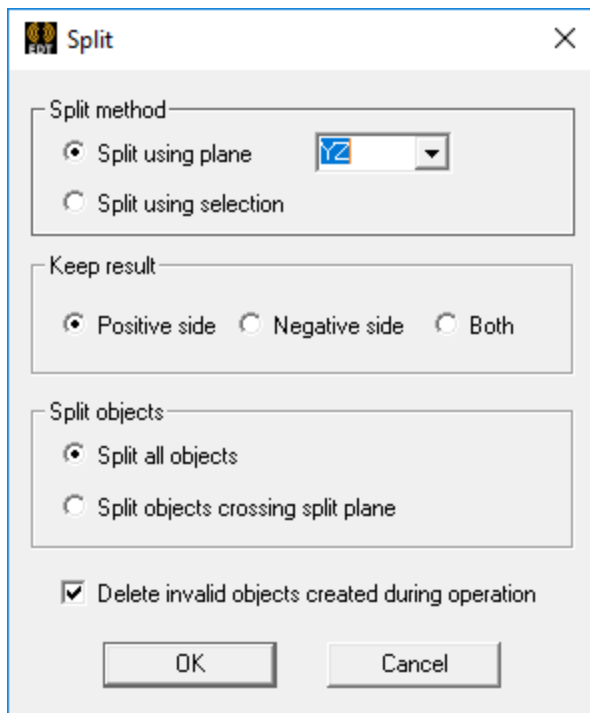

**Figure 3-26: *Split* Dialog Box**

4. Accept the defaults for the remaining options and click **OK** to split the entire model.
5. Clear the current selection.

Your final model should appear similar to the figure below:

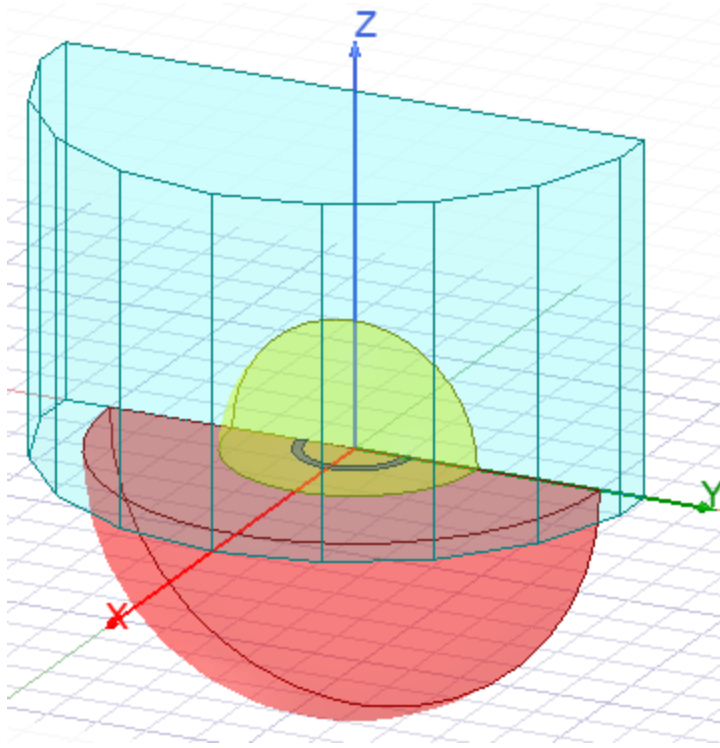

**Figure 3-27: The Model After Split for YZ**

6.  **Save** the project.

You are now ready to assign ports and boundaries to your antenna model.

## 4 - Setting Up the Problem

Now that you created the geometry and assigned the materials and other attributes for the antenna problem, you are ready to define its boundaries and excitation ports.

This chapter contains the following topics:

- Define the boundary conditions, such as the location of the radiation boundary, the symmetry plane, and more.
- Define the lumped port through which the signal enters the antenna and modify its impedance multiplier to account for symmetry.
- Verify that you correctly assigned the boundaries and excitations to the model.

### Boundary Conditions

Boundaries specify the behavior of magnetic and electric fields at various surfaces. They can also be used to identify special surfaces, such as resistors, whose characteristics differ from the typical boundaries.

The following four types of boundary conditions are used for this antenna problem:

<b>Radiation</b>	This type of boundary simulates an open region that allows waves to radiate infinitely far into space, such as antenna designs. HFSS absorbs the wave at the radiation boundary, essentially ballooning the boundary infinitely far away from the structure. In this antenna model, the air volume object is defined as a radiation boundary.
<b>Perfect E</b>	This type of boundary models a perfectly conducting surface in a structure, which forces the electric field to be normal to the surface. In this antenna model, the <i>bottom</i> face of the air volume object is defined as a perfect E boundary.
<b>Perfect H</b>	This type of boundary forces the tangential component of the H-field to be the same on both sides of the boundary. In this antenna model, the annular feed ring is the aperture to which the Perfect H boundary is assigned. Because the aperture is defined as a perfect H boundary, the E-fields will radiate through it. If it were not defined as a perfect H boundary, the E-field would not radiate through, and the signal would terminate at the aperture.
<b>Symmetry</b>	In structures that have an electromagnetic plane of symmetry, such as this antenna model, the problem can be simplified by modeling only one-half of the actual device and identifying faces along the symmetry plane as a perfect H or perfect E boundary. For this antenna problem, a perfect H symmetry boundary is used.

## Assign a Radiation Boundary to the Air Volume

The first boundary you will assign is a radiation boundary to the entire air volume object. This boundary is defined first because the Perfect E, Perfect H, and Symmetry boundaries you will apply later must override the radiation boundary at a total of two Air Volume faces. Wherever they coincide, subsequently applied boundary conditions override those applied at an earlier time. You could apply the radiation boundary later, but then you would have to select the many individual outside faces of the air volume object (excluding the Perfect E and Symmetry faces), which is far less convenient.

### Note:

Boundaries accidentally applied in the wrong order can be reordered via the menu bar command, **HFSS > Boundaries > Reprioritize**.

Radiation boundary model surfaces represent open space. Energy is allowed to radiate from these boundaries instead of being contained within them. A radiation surface does not have to be spherical, but it must be exposed to the background (that is, surrounding environment), convex with regard to the radiation source, and located at least a quarter wavelength from the radiating source. In some cases the radiation boundary may be located closer than one-quarter wavelength, such as portions of the radiation boundary where little radiated energy is expected.

To assign a radiation boundary to the air volume object:

1. Select **AirVolume** from the History Tree.
2. From the menu bar, click **HFSS > Boundaries > Assign > Radiation**.

The *Radiation Boundary* dialog box appears.

3. Verify that **Name = Rad1**.
4. Click **OK**.

The resulting radiation boundary is applied to the object **AirVolume** and now appears as a subentry under **Boundaries** in the Project Manager.

5. From the **Draw** ribbon tab, click  **Orient**.

The default **Trimetric** view of the model is restored.

If the boundary visualization is not displayed, select **Boundaries > Rad1** from the Project Manager.

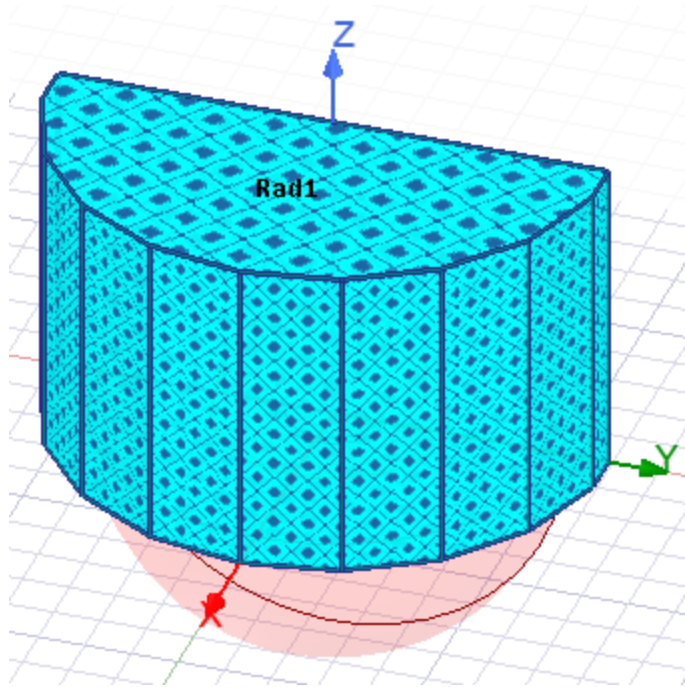

Figure 4-1: Radiation Boundary Assigned to *AirVolume*

**Note:**

For this antenna problem, it is not necessary to edit any boundary's visualization default settings.

**Tip:**

To edit a boundary's visualization settings:

1. From the menu bar, click **HFSS > Boundaries > Visualization** if you want to show or hide boundaries. The *Boundary Visualization Options* window appears.
2. Deselect the **View Geometry**, **View Name**, or **View Vector** options of boundaries that you want to hide from view. Select the options you want to show in the *Modeler* window. Visualization changes are applied immediately when a check-box state is toggled.
3. Click **Close** when finished.

## Assign a Perfect E Boundary to the Air Volume

Next, you must define the intersection between the cavity and the air volume as a perfect E boundary condition. The top of the cavity is a conducting layer, which is the ground plane of the antenna. The area beyond the cavity radius continues to be a conducting layer. Therefore, you will assign a perfect E boundary to the *bottom* face of the air volume object.

By default, all HFSS model surfaces without a user-defined boundary condition are assumed to have perfectly conducting walls. The surfaces of all model objects that have been assigned perfectly conducting materials are automatically assigned perfect E boundaries. The electric field is assumed to be normal to these surfaces. The final field solution must match the case in which the tangential component of the electric field goes to zero at perfect E boundaries.

To assign a perfect E boundary to the bottom face of the air volume object:

1. Deselect the radiation boundary you just assigned.
2. Press **F** to begin the *Face* selection mode.
3. Select the *bottom* face of the object *AirVolume* as follows:
  - a. Select a face on the **AirVolume** object, taking care to click at a point where only the bottom face is immediately behind the clicked point, as shown below:

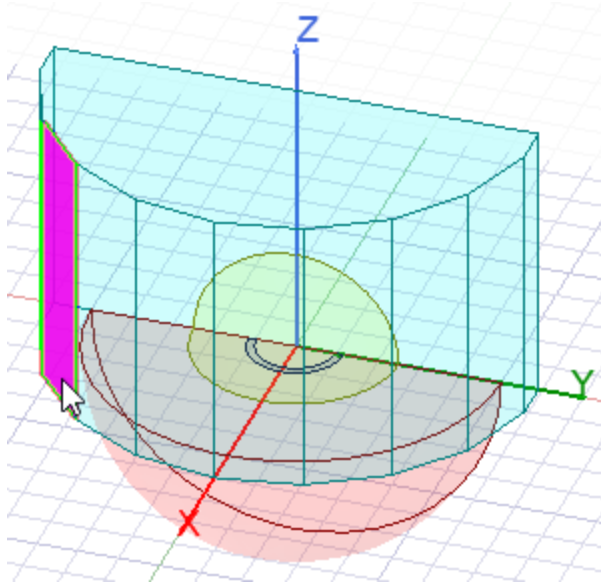

- b. Press **B** (for select *Next Behind*), and the *AirVolume* **bottom** will become the selected face. (If the cursor was too high when you clicked, the selection may be of the top face of cavity, the spherical face of the dielectric, or the back face of the air volume.)

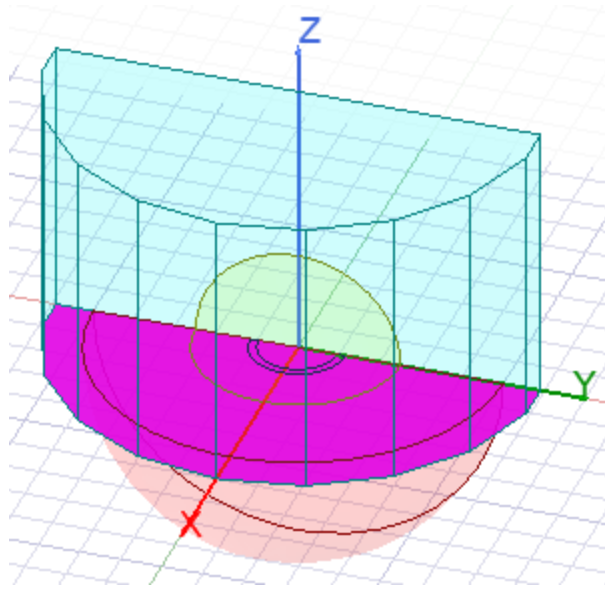

**Figure 4-2: Bottom Face of AirVolume Selected**

4. Right-click in the Modeler window and choose **Assign Boundary > Perfect E** from the shortcut menu.

The *Perfect E Boundary* dialog box appears.

5. Ensure that **Infinite Ground Plane** is **cleared** (not selected).

**Note:**

If selected, this option simulates the effects of an infinite ground plane. It only affects the calculation of near- and far-field radiation during post processing. The 3D Post Processor models the boundary as a finite portion of an infinite, perfectly conducting plane.

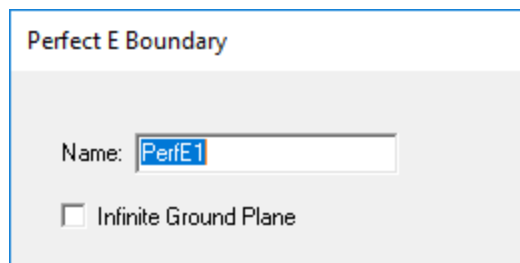

**Figure 4-3: Perfect E Boundary**

6. Click **OK**.

The resulting perfect E boundary condition is assigned to the bottom face of the object *AirVolume*:

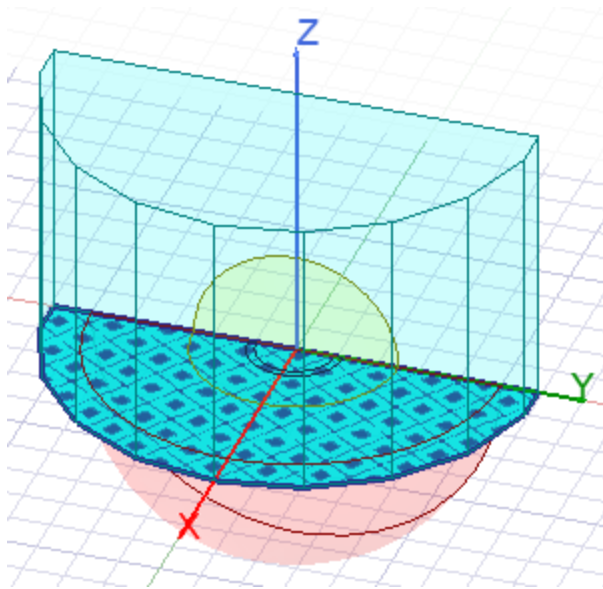

Figure 4-4: Perfect E Boundary Applied

### Assign a Perfect H Boundary to the Annular Ring

Next, assign a perfect H boundary to the annular ring. Over the annular ring area, this boundary will supersede the Perfect H boundary you just assigned to the annular ring. So, as you can see again, the order of application of boundary conditions is important when they overlap.

A perfect H boundary represents a surface at which the tangential component of the H-field is the same on both sides. For internal planes, such as the annular ring in this antenna model, this assignment results in a natural boundary through which the field propagates. For planes on the outer surface of the model, this assignment results in a boundary that simulates a perfect magnetic conductor, in which the tangential component of the H-field is zero.

From the previous operation, you should still be in the *Face* selection mode. To assign a perfect H boundary to the face of annular ring:

1. Deselect the perfect E boundary you just assigned.
2. On the History Tree, select **AnnularRing**.
3. Right-click in the Modeler window and choose **Assign > Boundary > Perfect H**.

The *Perfect H Boundary* dialog box appears.

4. Click **OK**.

The Perfect H boundary is assigned:

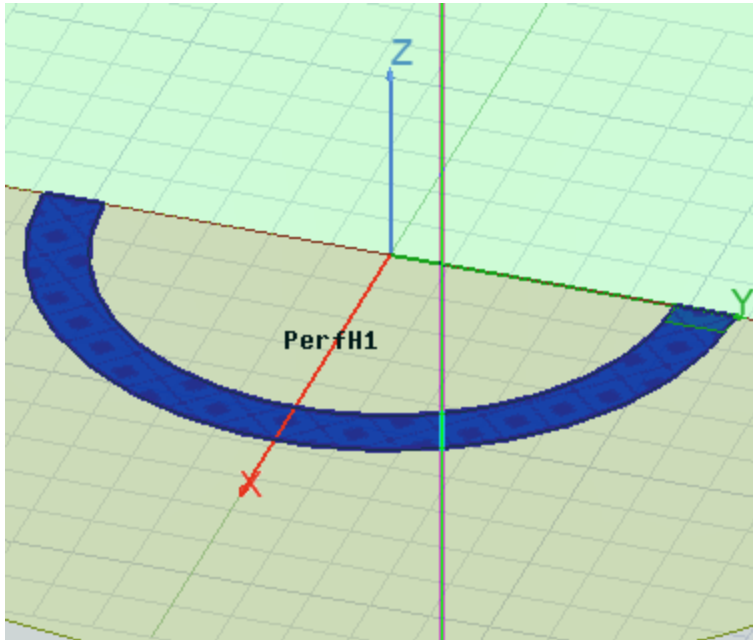

**Figure 4-5: Perfect H Boundary Assigned**

5. Clear the Perfect H boundary selection.

### Assign a Symmetry Boundary to the Model

HFSS has a boundary condition specifically for symmetry planes. Instead of defining a perfect E or perfect H boundary, you define a perfect E or perfect H symmetry plane.

When you are defining a symmetry plane, you must decide which type of symmetry boundary should be used, Perfect **E** or Perfect **H**. In general, use the following guidelines to decide which type of symmetry plane to use:

- If the symmetry is such that the E-field is normal to the symmetry plane, use a perfect **E** symmetry plane.
- If the symmetry is such that the E-field is tangential to the symmetry plane, use a perfect **H** symmetry plane.

The simple two-port rectangular waveguide shown below illustrates the differences between the two types of symmetry planes. The E-field of the dominant mode signal ( $TE_{10}$ ) is shown. The waveguide has two planes of symmetry, one vertically through the center and one horizontally.

- The horizontal plane of symmetry is a Perfect **E** surface. The E-field is normal and the H-field tangential to that surface.
- The vertical plane of symmetry is a Perfect **H** surface. The E-field is tangential and the H-field normal to that surface.

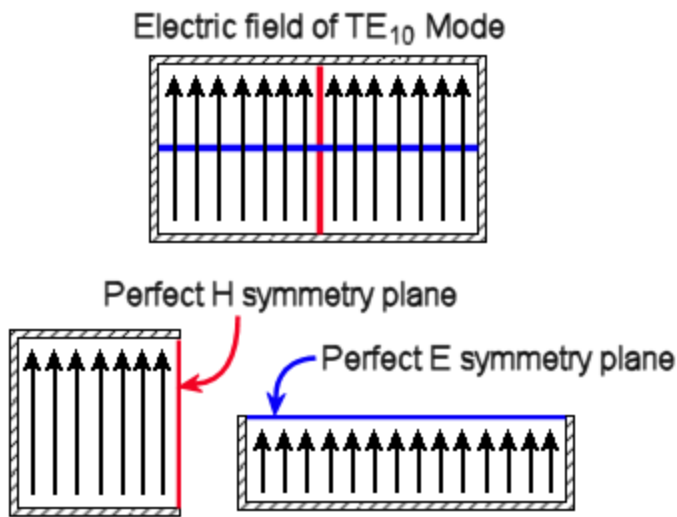

**Figure 4-6: Electric Field and Symmetry planes**



Since the antenna model in this guide has a vertical plane of symmetry and the E-field is tangential to the surface, apply a Perfect H boundary to the faces along the symmetry plane.

You will assign a perfect H symmetry boundary to the splitting plane faces of the objects *AirVolume* and *Cavity* (about which the model is symmetrical).

**Note:**

You do not need to apply the symmetry boundary condition to the cut face of the object *Dielectric*, because this object is fully encompassed by the **AirVolume**. Therefore, the cut face of *AirVolume* includes the area corresponding to the cut face of *Dielectric*. HFSS also includes logic to override, throughout a region of overlapping volumes, the material properties of a larger object with the material properties of a smaller object that it envelopes. So, it is also not necessary for you to subtract the *Dielectric* volume from the *AirVolume*. However, if you did choose to subtract the *Dielectric* volume from the *AirVolume*, then you would have to apply the symmetry boundary condition to the cut face of the *Dielectric* too. (In that case, the cut face of the object *AirVolume* would no longer encompass the *Dielectric* face.)

From the previous operations, you should still be in the *Face* selection mode. To assign a perfect H symmetry boundary to the model's symmetry plane:

1. From the **Draw** ribbon tab, click  **Orient** >  **Back (+X)**.
2. Select the symmetry faces (that is, those along the YZ splitting plane) of **AirVolume** and **Cavity**, as shown below:

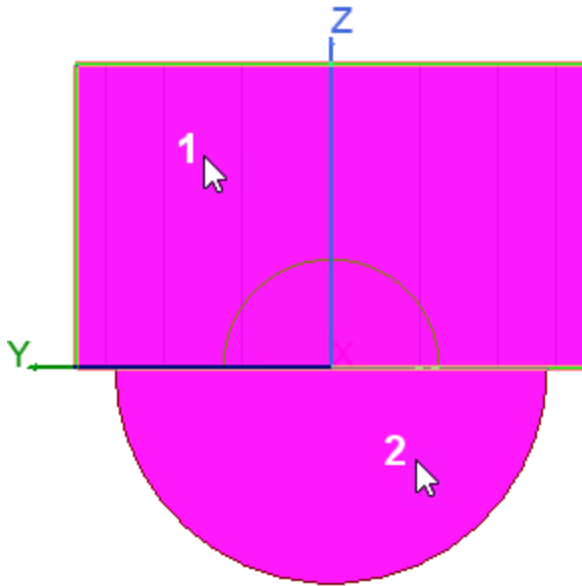

**Figure 4-7: Symmetry Faces Selected**

3. From the menu bar, click **HFSS > Boundaries > Assign > Symmetry**.

The *Symmetry Boundary* dialog box appears.

4. Verify that the default name is **Sym1**.
5. Select **Perfect H** as the **Symmetry** type, and click **OK**.

The resulting perfect H symmetry boundary condition is assigned to the faces of the objects **AirVolume** and **Cavity**.

If the boundary visualization is not displayed, select **Boundaries > Sym1** from the Project Manager.

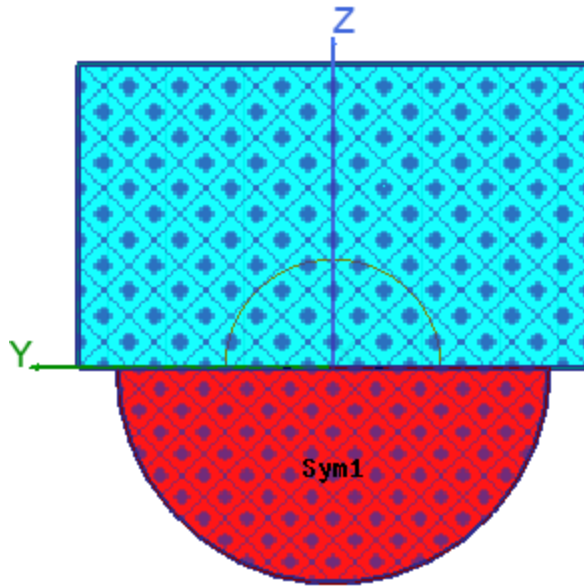

**Figure 4-8: Symmetry Boundary Applied**

6. Clear the current selection.
7. You have completed the boundary application phase. It's a good time to  **Save** the model.

Next, you will apply excitations.

## Excitation Conditions

Ports define surfaces exposed to non-existent materials (generally the background or materials defined to be perfect conductors), through which excitation signals enter and leave the structure. One lumped port will be defined for this antenna problem. Lumped ports are similar to traditional wave ports, but can be located internally and have a complex user-defined impedance. Lumped ports compute S-parameters directly at the port. A lumped port can be defined as a rectangle from the edge of a trace to the ground or as a traditional wave port. The default boundary is perfect H on all edges that do not come in contact with a conductor.

### Assign a Lumped Port Across the Gap

For this antenna problem, the engineering focus is on the behavior of the antenna itself, not its feed. Therefore, the model will feed with a lumped port across the annular slot, or gap object. Lumped ports are similar to traditional wave ports, but can be located internally and have a complex user-defined impedance. Lumped ports compute S-parameters directly at the port. A lumped port can be defined as a rectangle from the edge of the trace to the ground, as in this antenna problem, or as a traditional wave port. The default boundary is perfect H on all edges that do not come in contact with the metal.

**Note:**

The setup of a lumped port varies slightly depending on whether the solution is modal or terminal. As a reminder, the solution type for this antenna problem is modal driven.

To assign a lumped port across the gap object:

1. From the **Draw** ribbon tab, click  **Orient** to restore the default *Trimetric* view orientation.
2. In the History Tree, click **Gap** to select it:

**Note:**

Recall that *Gap* is the rectangle you renamed (it's a planar sheet object with no material assignment). You should look under *Sheets > Unassigned*.

3. Zoom in on the area where the gap object is located to see it clearly. The easiest way to do so is to place the cursor at the center of the area of focus and roll the mouse wheel upward (away from you). This moves the *viewpoint camera* closer to the model.

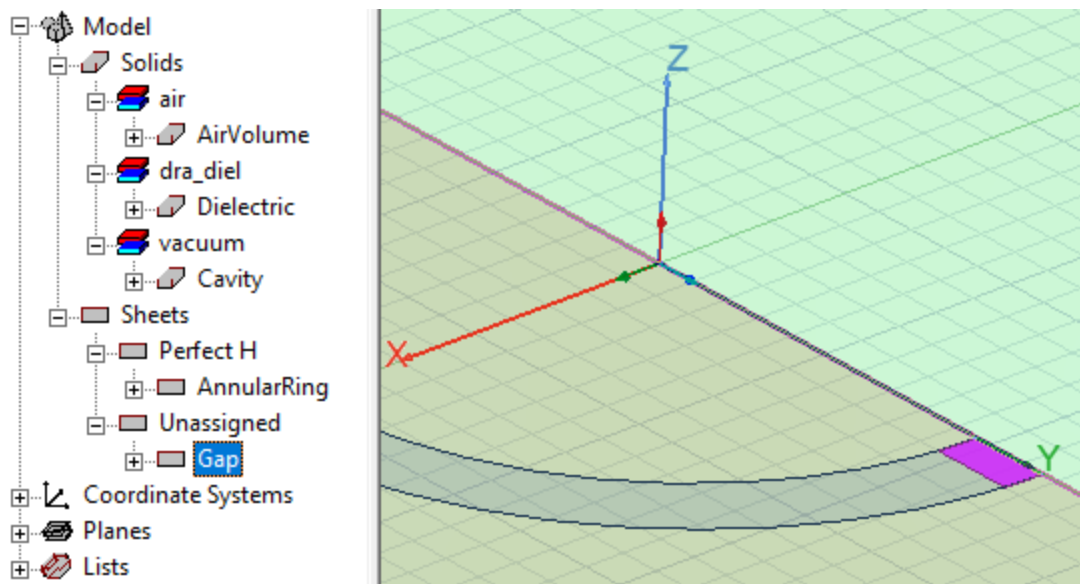

**Figure 4-9: Gap Selected**

4. From the menu bar, click **HFSS > Excitations > Assign > Port > Lumped Port**.

The *Lumped Port* dialog box appears displaying the *General* step of the lumped port setup process.

**Note:**

The first time you assign a lumped port, HFSS walks you through the process with a step-by-step wizard.

5. Enter the **Name** and **Full Port Impedance** values as shown in the following figure:

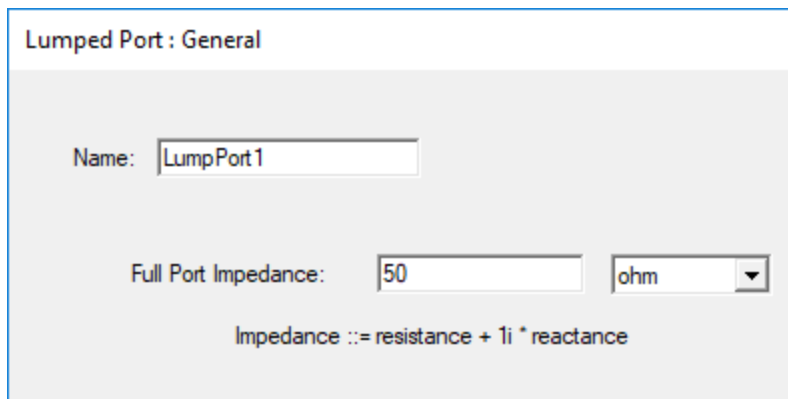
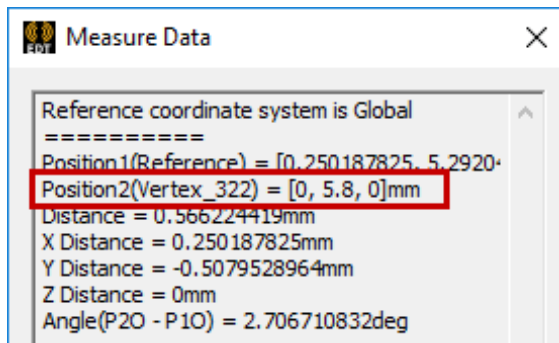

**Figure 4-10: Lumped Port : General Dialog Box**

6. Click **Next**.
7. In the *Lumped Port : Modes* step, click in the **Integration Line** column of *Mode 1* and select **New Line**.

The cursor changes to a dotted line and the *Measure Data* and *Create Line* dialog boxes appear.

8. Click the start point (**0, 5.8, 0**), as shown in the figure below. This is the vertex at the +Y end of the long *Gap* edge that lies along the symmetry boundary. The cursor also becomes a solid black square at the endpoints of the gap edges (snapping point).

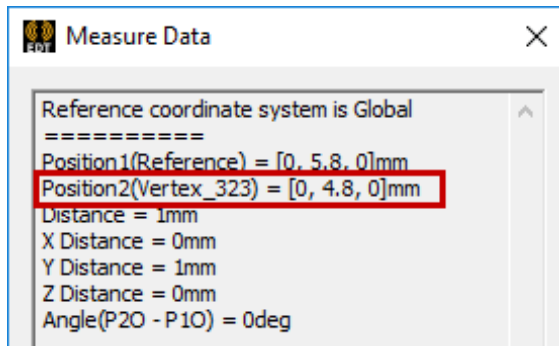

**Figure 4-11: Measure Data – Integration Line Start Point**

**Note:**

Use the Measure Data dialog box as reference as you move your cursor to reach (0, 5.8, 0).

- Click the end point (0, 4.8, 0) as shown in the following figure. This is the vertex at the -Y end of the long *Gap* edge that lies along the symmetry boundary.



**Figure 4-12: Measure Data – Integration Line Endpoint**

**Note:**

The two points defines the direction and length of the integration line.

The *Lumped Port* dialog box reappears as soon as you click the second point.

- Click **Next**.  
The *Lumped Port : Post Processing* step appears.
- Select **Do Not Renormalize** and click **Finish**.  
The resulting lumped port is assigned across the object *Gap*.
- To display the lumped port and integration line visualization, select **Excitations > LumpPort1** in the Project Manager.

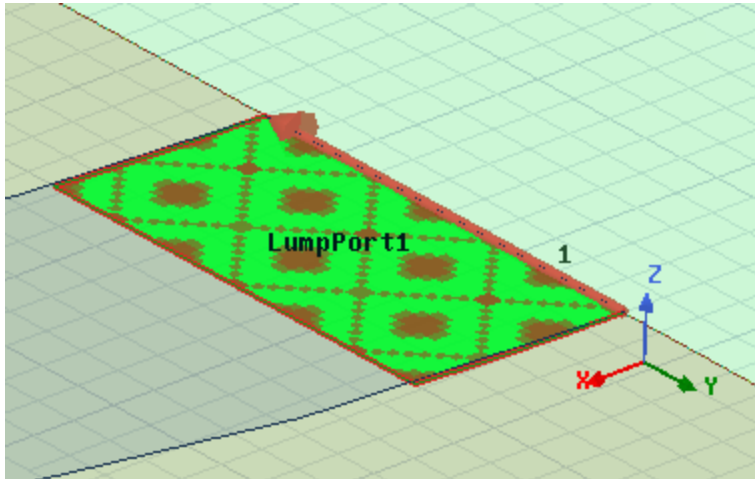

Figure 4-13: Lumped Port Assigned

13. On the **Draw** ribbon tab, click  **Fit All** to fit the full model to the viewing area.
14. Click in the Modeler window's background area to clear the current selection.

## Modify the Impedance Multiplier

Because you cut the full model in half and defined a symmetry plane, the computations must be adjusted by specifying an impedance multiplier.

In cases such as this antenna problem, where a perfect H symmetry plane splits a structure in two, only one-half of the power flow is seen by the system, but the full voltage differential is present. Therefore, such half-symmetry models result in computed impedances that are twice those of the full structure. To account for this effect, you must specify an impedance multiplier of 0.5.

To edit the impedance multiplier:

1. Right-click **Excitations** in the Project Manager and select **Edit Port Impedance Multiplier** from the shortcut menu.

The *Edit Port Impedance Multiplier* dialog box appears.

2. Enter **0.5** for the **Set the port impedance multiplier for the design** value:

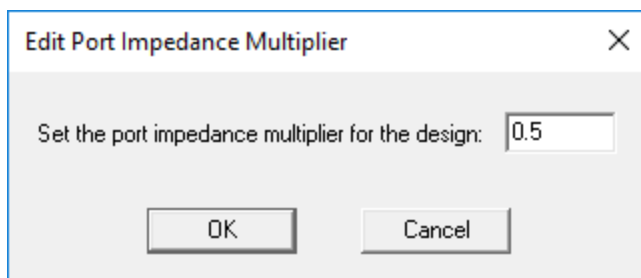

**Figure 4-14: Edit Port Impedance Multiplier Dialog Box**

3. Click **OK**.

**Verify All Boundary and Excitation Assignments**

Now that you have assigned all the necessary boundaries and excitations to the model, you should review them in the solver view. When you verify boundaries and excitations in the solver view, you review their locations as you have defined them for generating a solution (solving).

As you have seen previously, you can select specific *Boundaries* or *Excitations* in the Project Manager to display their visualizations on the model. The *Solver View of Boundaries* identifies the boundaries and excitations differently. It uses solid, user-customizable colors that remain visible as you select or deselect objects or manipulate the model view (as long as you leave the *Solver View of Boundaries* dialog box open).

To check the solver's view of boundaries and excitations:

1. From the menu bar, click **HFSS > Boundary Display (Solver View)**.

HFSS runs an initial mesh and determines the locations of the boundaries and excitations on the model.

The **Solver View of Boundaries** dialog box appears, which lists all the boundaries and excitations for the active model in the order in which they were assigned (or the order specified in the *Reprioritize Boundaries and Excitations* dialog box. It also shows the default boundary that is assigned automatically by the program to *outer* faces that lack a user-specified boundary condition.

**Important:**

The order of the boundary and excitations in this dialog box is important. If two assignments overlap on the model (such as PerfE1, PerfH1, and LumpPort1), the latter assignment overrides the former assignment. Be sure that the assignments on smaller faces are not being overridden by the assignment of a larger overlapping face, due to an error in the order of the boundaries and excitations.

2. Select the four checkboxes in the **Visibility** column indicated in the following figure:

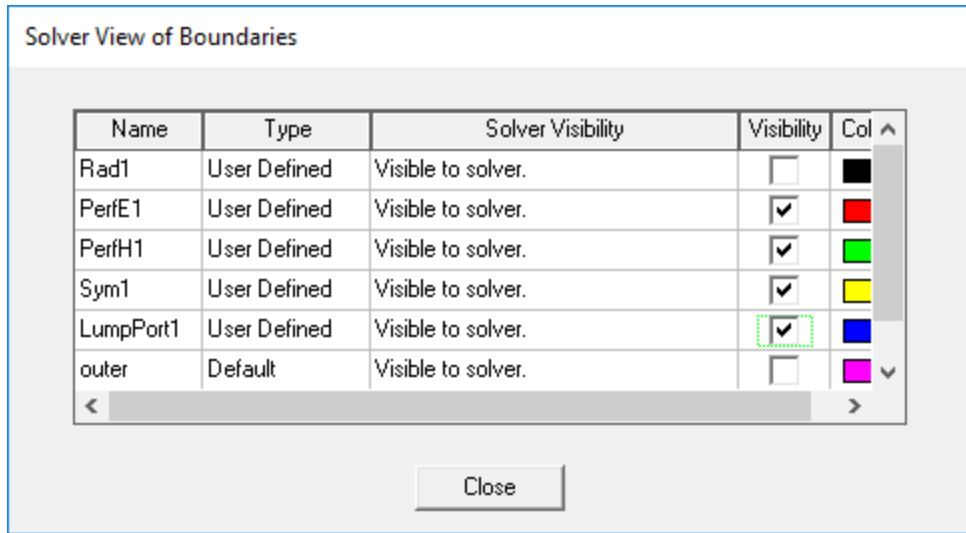

**Figure 4-15: Solver View of Boundaries Dialog Box**

Notice that the four colors associated with *PerfE1*, *PerfH1*, *Sym1*, and *LumpPort1* are all visible on the model and that they are in the proper order to prevent any boundary or excitation from being incorrectly overridden:

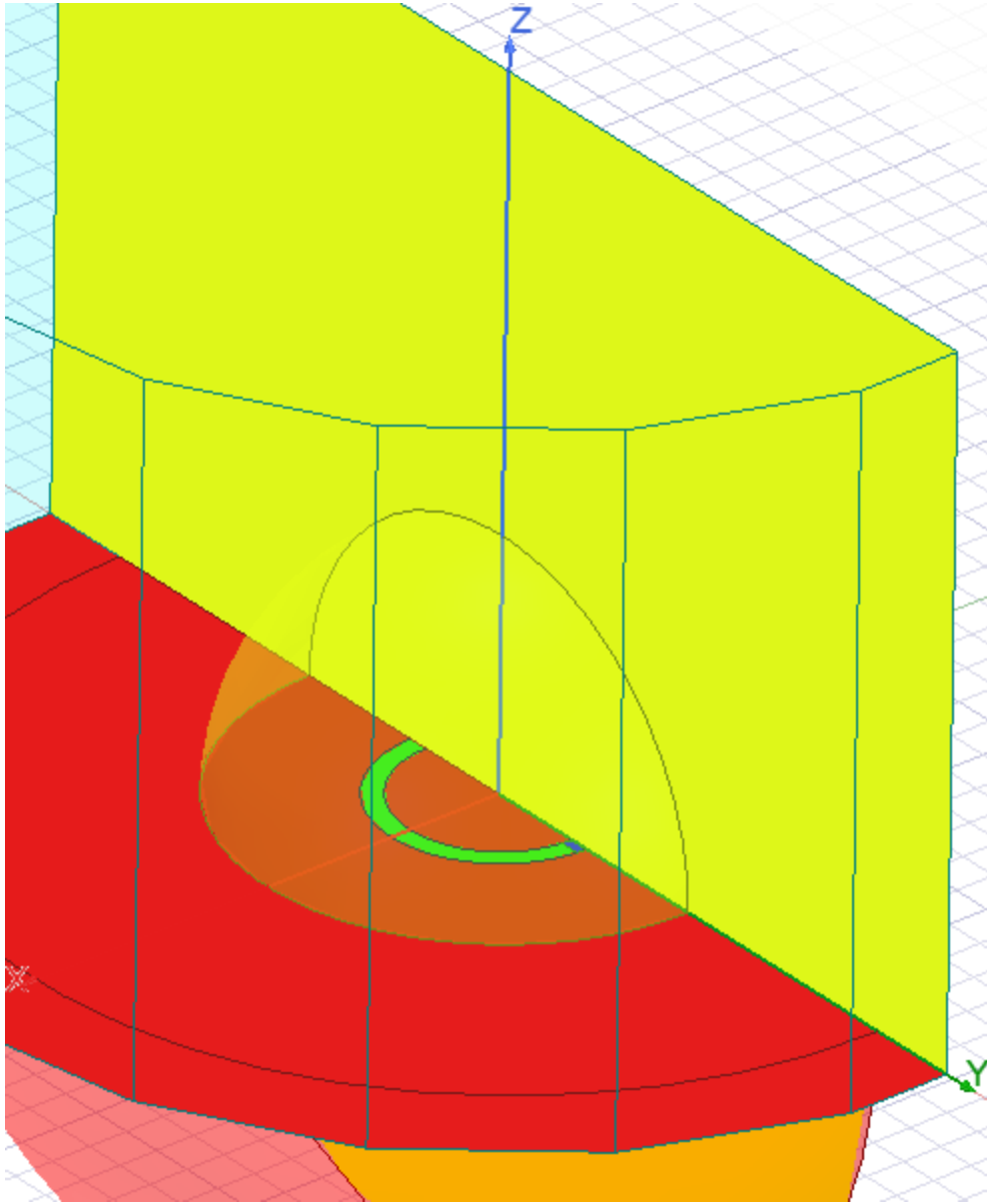

**Figure 4-16: Solver View of Boundaries – *PerE1*, *PerfH1*, *Sym1*, and *LumpPort1* Selected**

**Note:**

- **Visible to Solver** appears in the **Solver Visibility** column for each boundary that is valid (that is, represented in the solution).
- **Overridden** will appear in the **Solver Visibility** column for any boundary or excitation that is completely overridden by a boundary or excitation that overlaps it (that is, not represented in the solution). *LumpPort1* locally overrides a portion of *PerfH1*, and both of these two boundaries locally override a portion of *PerfE1*. However, *PerfE1* is not listed as "Overridden" because it is still visible to the solver (therefore, it participates in the solution). Actually, the vast majority of *PerfE1* is intact.

3. Verify that the boundaries or excitations you assigned to the model are being displayed as intended for solving purposes. (See the preceding two figures.)
4. Modify the parameters or priority for those boundaries or excitations, if any, that are not being displayed as intended.
5. Click **Close**, and then click  **Save**.

You are now ready to set up the solution parameters for this antenna problem and generate a solution.

## 5 - Generating a Solution

Now that you have created the geometry and set up the model, you are ready to generate a solution.

Your goals for this chapter are to:

- Set up the solution parameters
  - Add a frequency sweep to the solution.
- Define meshing instructions.
- Validate the project setup.
- Generate a solution.
- View the solution data:
  - Profile
  - Convergence
  - Matrix

### Add Solution Setup

Now, you will specify how HFSS will compute the solution by adding a solution setup to the antenna project's design.

To add a solution setup to the design:

1. On the Simulation ribbon tab, click  **Setup > Advanced**.

The *Solution Setup* dialog box appears:

2. Under the **General** tab, enter the values shown in the following figure:

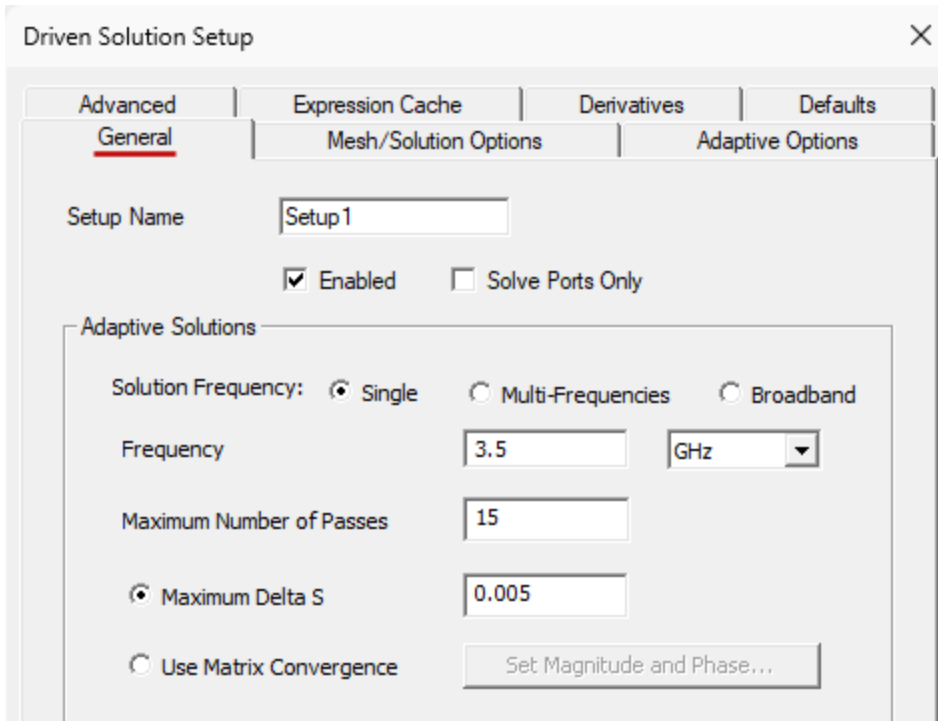

Figure 5-1: Driven Solution Setup Dialog Box – General Tab

3. Select the **Mesh/Solution Options** tab.
4. In the *Initial Mesh Options* section, deselect **Use Default Value** and enter the **Lambda Target** value shown in the following figure:

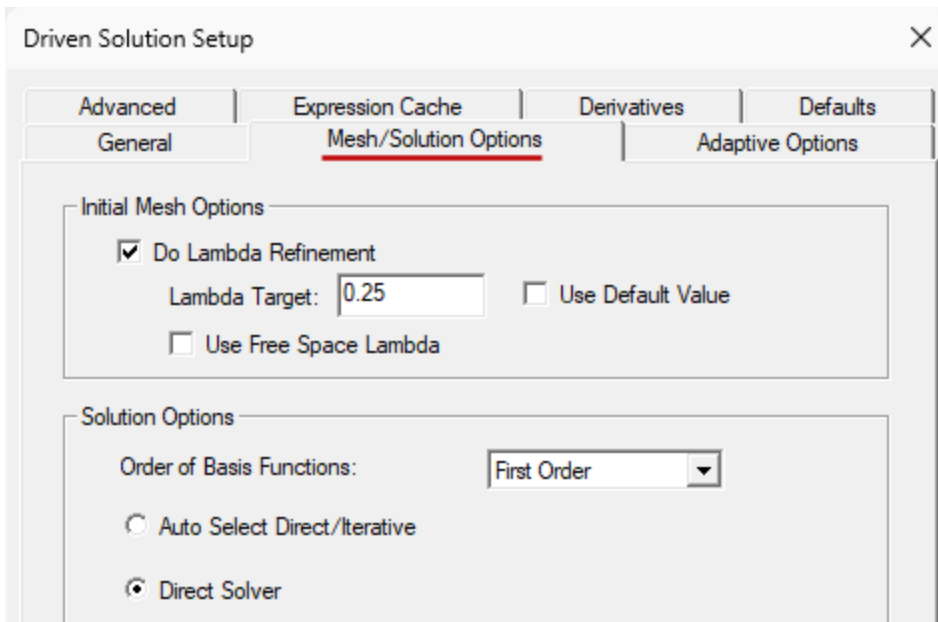

Figure 5-2: Driven Solution Setup Dialog Box – Mesh/Solution Options Tab

5. Click **OK**.

The *Edit Frequency Sweep* dialog box opens automatically when you first add an advanced solution setup to an HFSS design that already has at least one port assigned. Leave this dialog box open and continue to the next page for instructions on defining the sweep.

## **Add a Frequency Sweep to the Solution Setup**

To generate a solution across a range of frequencies, add a frequency sweep to the solution setup. HFSS performs the sweep after the adaptive solution.

For this antenna model, you will add a *Fast* frequency sweep to the solution setup. A Fast sweep generates a unique full-field solution for each division within a frequency range. It is best for models that will abruptly resonate or change operation in the frequency band, and obtains an accurate representation of the behavior near the resonance.

The *Edit Frequency Sweep* dialog box should already be open as a result of adding the solution setup in the previous procedure.

Define a fast frequency sweep as follows:

1. Enter the settings shown in the following figure:

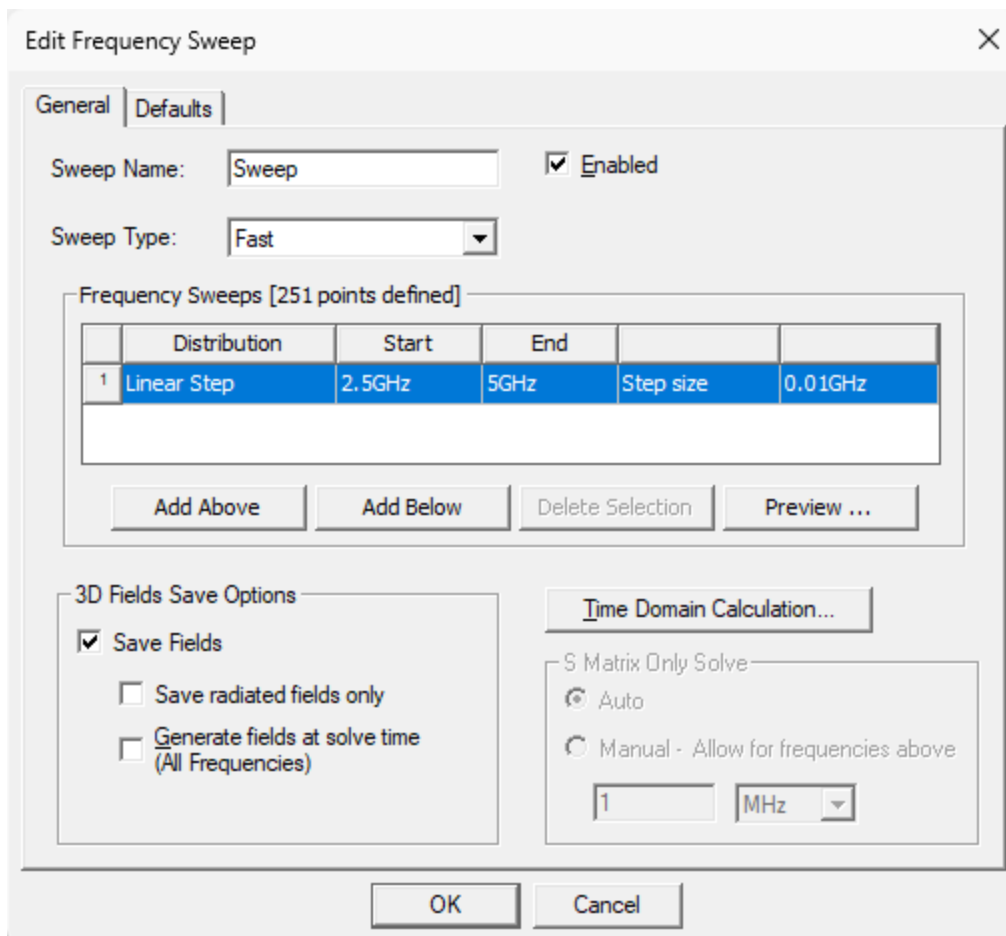

**Figure 5-3: Edit Frequency Sweep Dialog Box**

**Note:**

If you do not select *Save Fields*, the field solution will not be saved for each solved point in the frequency sweep. Therefore, the field solutions will not be available during post processing.

2. Optionally, click **Preview** to display each of the sweep values within the frequency range at the 0.01 GHz step size increment you specified. Click **Close** when finished looking at the 251 sweep points.
3. Click **OK** to add the sweep and close the dialog box.

*Setup1* and *Sweep1* appear under *Analysis* in the Project Manager:

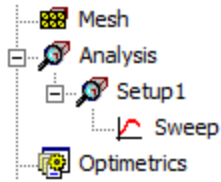

Figure 5-4: *Setup1* and its *Sweep* Listed in the Project Manager

## Define Mesh Operations

In HFSS, mesh operations are optional mesh refinement settings that you specify before a mesh is generated. The technique of providing HFSS with mesh construction guidance is referred to as “seeding” the mesh.

Since the fields in the annular feed ring are very important in this antenna model, you will provide some meshing instructions at this object. Specifically, you will assign a length-based mesh refinement to the annular feed ring. This refinement instructs HFSS to reduce the length of tetrahedral elements in the designated area until they are below a specified value. The length of a tetrahedral element is defined as the length of its longest edge.

You can specify the maximum length of tetrahedra on faces or inside of objects. You can also specify the maximum number of elements that are added during the refinement. The refinement criteria you specify is used to guide the meshing process, affecting the size and number of elements generated.

To assign a length-based mesh refinement to the annular feed ring:

1. Select **Annular\_Ring** under *Sheets > Perfect H* in the History Tree.
2. Using the menu bar, click **HFSS > Mesh > Assign Mesh Operation > On Selection > Length Based**.

### Note:

Applying the *On Selection* command refines *every* face of the selected object or objects. However, in this case, *Annular\_Ring* only has one face.

The *Element Length Based Refinement* dialog box appears.

3. Restrict the length of tetrahedra edges touching the faces, as detailed in the bullet points and figure below:
  - Ensure that **Set maximum element length** is selected.
  - Enter **0.5 mm** in the text box to the right of this option.

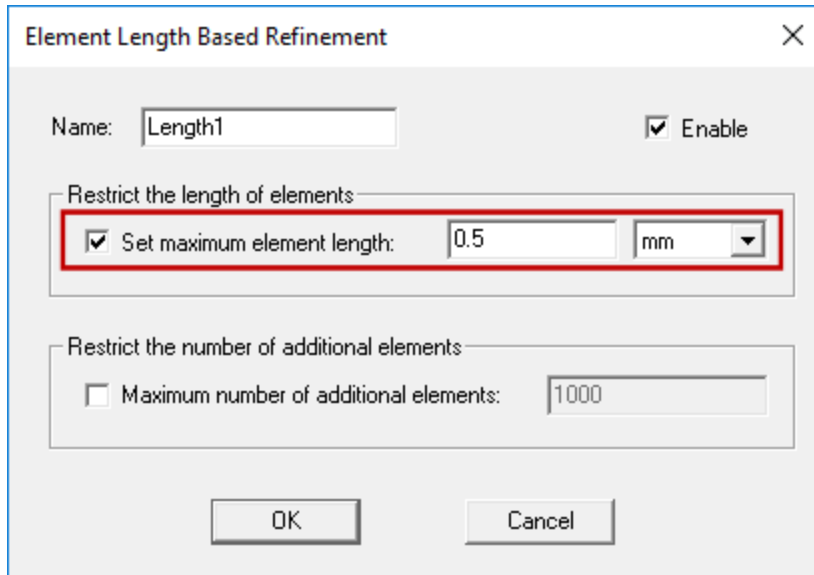

**Figure 5-5: Element Length Based Refinement Dialog Box**

**Note:**

HFSS refines the element edges touching the selected faces or faces until they are equal to or less than the specified value.

4. Accept the default name **Length1**.
5. Ensure that **Maximum number of additional elements** is **cleared** (*not* selected).

**Note:**

If selected, this option restricts the number of elements added during the refinement process, even if the size criterion has not been satisfied.

6. Click **OK**.

The *Length1* refinement now appears under *Mesh* in the Project Manager.

7.  **Save** the changes you've made to your project.

## Validate the Project Setup

Before you run an analysis on the antenna model, it is important to first perform a validation check on the project. HFSS runs a check on all the setup details of the active project to verify that the necessary steps have been completed and their parameters are reasonable.

To perform a validation check on the project *DRA*:

1. On the **Simulation** ribbon tab, click  **Validate**.

The *Validation Check* window appears, and HFSS checks the project setup.

2. View the results in the *Validation Check* window:

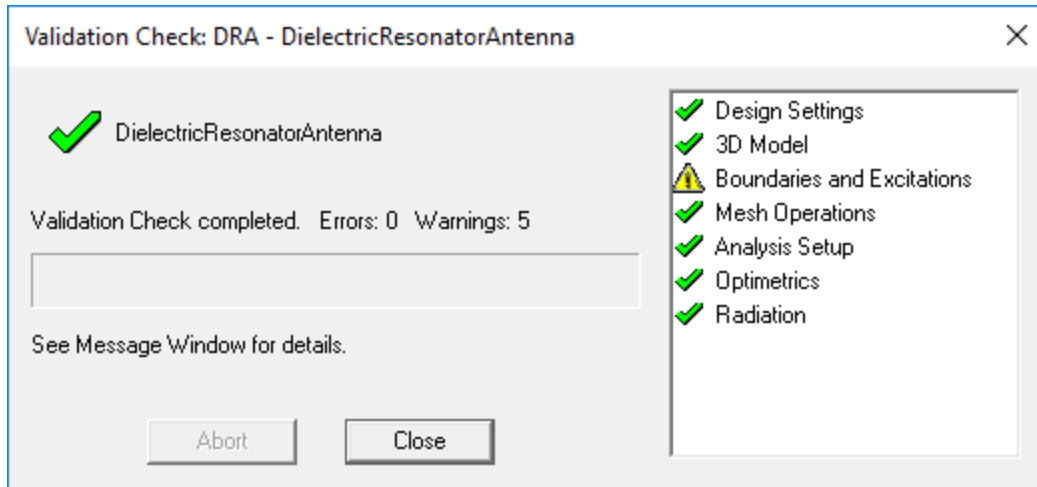

**Figure 5-6: Validation Check Window**

**Note:**

For this antenna project, a warning triangle appears at Boundaries and Excitations. There are several associated warnings in the Message Manager window concerning overlapping boundaries. Using the solver view of the boundaries, you have already verified that the solver will use the correct boundary for each face. You can disregard the warnings and run the simulation.

3. Click **Close**.
4.  **Save** the changes you've made to your project.

## Generate the Solution

Now that you have entered all the appropriate solution criteria and defined the mesh operations, the antenna problem is ready to be solved.

When you set up the solution criteria, you specified values for an adaptive analysis. An adaptive analysis is a solution process in which the mesh is refined iteratively in regions where the error is high, which increases the solution's accuracy. You set the criteria that control mesh refinement during an adaptive field solution. Many problems can be solved using only adaptive refinement. Others may require five, ten, or more iterations to converge. For this exercise, you also specified that a minimum of two converged iterations are to be completed. The first time the convergence

criterion is satisfied, an additional iteration will be executed, after which the adaptations cease (assuming the additional iteration also satisfies the convergence criterion).

The following is the general process carried out during an adaptive analysis:

1. HFSS generates an initial mesh.
2. Using the initial mesh, HFSS computes the electromagnetic fields that exist inside the structure when it is excited at the solution frequency. (If you are running a frequency sweep, an adaptive solution is performed only at the specified solution frequency.)
3. Based on the current finite element solution, HFSS estimates the regions of the problem domain where significant solution error exists. Tetrahedra in these regions are refined.
4. HFSS generates another solution using the refined mesh.
5. The software recomputes the error, and the iterative process (solve — error analysis — refine) repeats until the convergence criteria are satisfied or the requested number of adaptive passes are complete.
6. If a frequency sweep is being performed, HFSS then solves the problem at the other frequency points without further mesh refinement.

### To begin the solution process:

1. On the **Simulation** ribbon tab, click  **Analyze All**. This command solves every solution setup in the design, though, in this design, there is only one solution setup.

HFSS computes the 3D field solution inside the structure.

The *Progress* window displays the solution progress as it occurs:

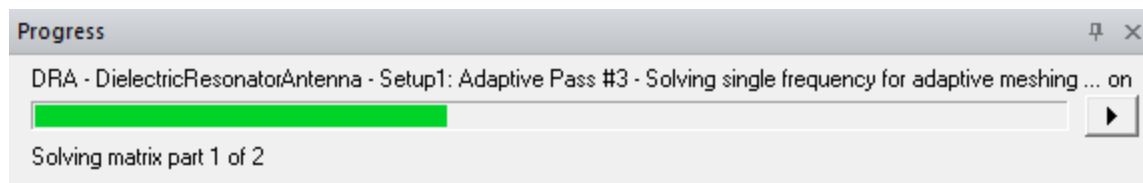

**Figure 5-7: Progress Window While Solving**

#### Note:

The results that you obtain should be approximately the same as the ones given in this getting started guide. However, there may be a slight variation between platforms and software versions.

## View the Solution Data

While the analysis is running, you can view a variety of solution data, as follows:

1. On the **Results** tab ribbon, click **Solution Data**.

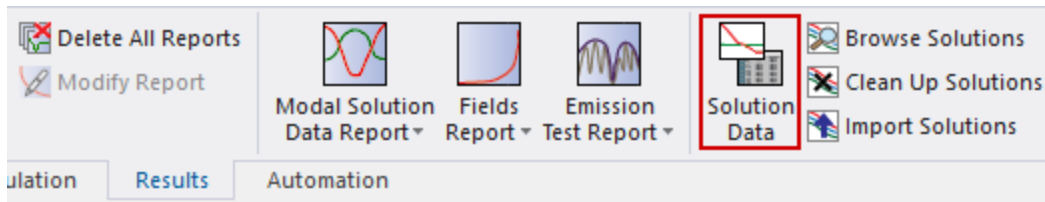

The *Solutions* window appears.

### Note:

Subsequent topics describe the tabs that constitute the *Solutions* window:

- Profile
- Convergence
- Matrix Data
- Mesh Statistics

Leave the *Solutions* window open while reviewing the contents of each tab.

## View the Profile Data

While the solution proceeds, examine the profile data, or computing resources, that were used by HFSS during the analysis.

The profile data is essentially a log of the tasks performed by HFSS during the solution. The log indicates the length of time each task took and how much RAM/disk memory was required.

To view the solution's profile data:

1. In the *Solutions* window, select the **Profile** tab, if it's not already selected.

Task	Real Time	CPU Time	Memory	
Adaptive Pass 4				Frequency: 3.5GHz
Adaptive Refine	00:00:00	00:00:00	29.8 M	Tetrahedra: 13762, Cores: 1
Simulation Setup	00:00:00	00:00:00	71.9 M	Tetrahedra: 13762, Disk: 5.5 KB
Matrix Assembly	00:00:00	00:00:03	198 M	Tetrahedra: 13762, Lumped ports: 1, Disk: 75 Bytes
Matrix Solve	00:00:01	00:00:10	637 M	Type: DCS, Cores: 12, Matrix size: 85821, Matrix bandwidth
Field Recovery	00:00:00	00:00:02	637 M	Excitations: 1, Disk: 535 KB
Data Transfer	00:00:00	00:00:00	90.3 M	Adaptive Pass 4
				Max Mag. Delta S: 0.00039
Adaptive Meshing				Elapsed Time: 00:00:20
				Adaptive Passes converged
Frequency Sweep				Time: 10/18/2022 17:41:12
				HPC: Enabled

**Figure 5-8: Solutions Window – Profile Tab**

**Note:**

To view the profile data if the *Solutions* window is not already open, right-click **Setup1** under *Analysis* in the Project Manager and choose **Profile**.

Notice that *Setup1* is selected as the solution setup in the *Simulation* drop-down menu. By default, the most recently solved solution is selected.

For the *Setup1* solution, you can view the following profile data:

<b>Task</b>	Lists the software module that performed a task during the solution process, and the type of task that was performed.  For example, for the task mesh3d_adapt, Mesh3d is the software module that adaptively refined the mesh.
<b>Real Time</b>	The amount of real time (clock time) required to perform the task.
<b>CPU Time</b>	The amount of CPU (Central Processing Unit) time required to perform the task.

<b>Memory</b>	The amount of RAM/virtual memory required of your machine to complete the task. This value includes the memory required of all applications running at the time, not just HFSS.
<b>Information</b>	The number of triangles, tetrahedra, and matrices generated.

- Keep the *Solutions* window open and proceed to the next topic.

## View Convergence Data

Next, view the convergence data, as follows:

- In the *Solutions* window, select the **Convergence** tab.

The screenshot shows the 'Convergence' tab in the HFSS Solutions window. It features a table of convergence data and several control panels. The table shows four passes with increasing numbers of solved elements and decreasing Max Mag. Delta S values. The 'CONVERGED' status is highlighted with a red arrow. The 'Consecutive Passes' section also shows a red arrow pointing to the current value of 2, which matches the target.

Pass Number	Solved Elements	Max Mag. Delta S
1	6797	N/A
2	8840	0.01117
3	11494	0.00020744
4	13762	0.00039065

Number of Passes:  
 Completed 4  
 Maximum 15  
 Minimum 1

Max Mag. Delta S:  
 Target 0.005  
 Current 0.00039065

View:  Table  Plot

Export...

CONVERGED

Consecutive Passes:  
 Target 2  
 Current 2

**Figure 5-9: Solutions Window – Convergence Tab**

You can view the following convergence data while the solution is still running:

- Number of adaptive passes completed
- Number of tetrahedra created at each completed adaptive pass
- Setup data (such as the *Maximum* allowed *Number of Passes* and the *Target* number of converged *Consecutive Passes*)
- For solutions with ports, as in *Setup1*, you can view the maximum change in the magnitude of the S-matrix coefficients between two consecutive passes, which is the convergence criterion. This information is available after two or more passes have been completed.

When the solution is complete, you can view the total number of adaptive passes that were performed and whether convergence was achieved. If the solution converged within the specified stopping criteria, fewer passes than requested may have been performed.

The convergence data can be displayed in table format or on a rectangular (X - Y) plot.

2. Select **Plot** to see a graph of the convergence history.

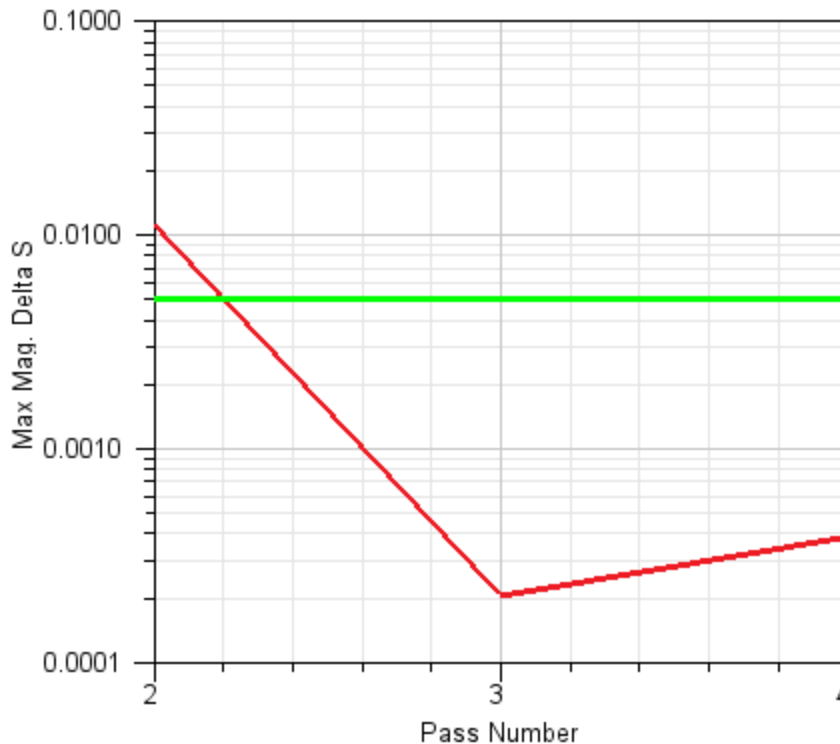

**Figure 5-10: Convergence Plot**

3. Keep the *Solutions* window open and proceed to the next topic.

## View Matrix Data

Next, view matrices computed for the S-parameters, impedances, and propagation constants during each adaptive and sweep solution.

To view matrices:

1. In the *Solutions* window, select the **Matrix Data** tab.
2. In the second **Simulation** drop-down menu, choose **Sweep**.

This option displays the matrix data for a selected sweep frequency or for every frequency in the sweep range.

3. Under the **View** subtab, select **Display All Frequencies**.

4. Also under the **View** subtab, ensure that the **S Matrix** option is selected as the type of matrix data you want to view.
5. Under the **Format** subtab, ensure that the **Magnitude/Phase(deg)** option is selected from the pull-down list as the format in which to display the matrix information.

Your results should resemble the following image:

Simulation: Setup1 Sweep

Design Variation:

Profile | Convergence | **Matrix Data** | Mesh Statistics

Default  Custom  Width: 8 Precision: 5  Use Scientific

Magnitude/Phase(deg)

View | **Format** | Passivity | Export

Freq		S:LumpPort1
3.7GHz	LumpPort1	( 0.51738, 159)
3.71GHz	LumpPort1	( 0.52887, 157)
3.72GHz	LumpPort1	( 0.5398, 156)
3.73GHz	LumpPort1	( 0.55022, 155)
3.74GHz	LumpPort1	( 0.56014, 153)
3.75GHz	LumpPort1	( 0.56959, 152)

**Figure 5-11: Solutions Window – Matrix Data Tab**

**Note:**

You can display matrix data in the following formats:

<b>Magnitude/Phase</b>	Displays the magnitude and phase of the matrix type.
<b>Real/Imaginary</b>	Displays the real and imaginary parts of the matrix type.
<b>dB/Phase</b>	Displays the magnitude in decibels and phase of the matrix type.
<b>Phase</b>	Displays the phase of the matrix type.
<b>Real</b>	Displays the real parts of the matrix type.
<b>Magnitude</b>	Displays the magnitude of the matrix type.
<b>Imaginary</b>	Displays the imaginary parts of the matrix type.
<b>dB</b>	Displays the magnitude in decibels of the matrix type.

- Alternatively, to show the matrix entries for one solved frequency, deselect **Display All Freqs**. Then, use the drop-down menu to select the solved frequency for which you want to view matrix entries.

For adaptive passes, only the solution frequency specified in the *Solution Setup* dialog box is available. For frequency sweeps, the entire frequency range is available.

- Keep the *Solutions* window open and proceed to the next topic.

## View Mesh Statistics

Finally, view the mesh statistics for the *DielectricResonatorAntenna* HFSS solution, as follows:

- In the *Solutions* window, select the **Mesh Statistics** tab to view data about the generated tetrahedral elements.

	Num Tets	Min edge length	Max edge length	RMS edge length	Min tet vol	Max tet vol	Mean tet vol	Std Devn (vol)
AirVolume	2036	2.37529	17.5	7.87049	0.472504	163.01	22.8469	25.4535
Cavity	4270	0.178585	18.2795	3.9547	9.56272e-05...	198.793	3.75343	12.6171
Dielectric	7456	0.180569	3.91086	1.64877	5.8562e-05...	2.20271	0.263556	0.326009

**Figure 5-12: Solutions Window – Mesh Statistics Tab**

The mesh statistics are listed separately for each part comprising the model, along with the total number of elements (reported above the table). The following mesh statistics are listed on this tab:

- Minimum, maximum, and RMS tetrahedra edge lengths
- Minimum, maximum, and mean tetrahedra volume
- Standard deviation of the tetrahedra volume.

**Note:**

You can click and drag the column header borders to resize any column width. You can also increase the *Solutions* window's overall size by clicking and dragging its outside border.

2. Click **Close** to exit the *Solutions* window.

Once the analysis has finished successfully, you can evaluate the results, as described in the next chapter.

## 6 - Evaluating the Results

Now that HFSS has generated a solution for the antenna problem, you can display and evaluate the results in many different ways. You can:

- Plot field overlays (representations of basic or derived field quantities) on surfaces or objects.
- Create 2D or 3D rectangular or circular plots and data tables of S-parameters, basic and derived field quantities, and radiated field data.
- Plot the finite element mesh on surfaces or within 3D objects.
- Create animations of field quantities, the finite element mesh, and defined project variables.
- Scale an excitation's magnitude and modify its phase.
- Delete solution data that you do not want to store.

For this antenna problem, you will specifically:

- Create Modal S-parameter reports.
- Create a field overlay plot of the magnitude of E on the top face of the antenna's cavity.
- Create an animation of the mag-E plot.

**Time** It should take you approximately 1 hour to work through this chapter.



### Create an S-Parameters Report

To generate a rectangular (2D) plot of S(LumpPort1,LumpPort1):

1. On the **Results** ribbon tab, click  **Modal Solution Data Report** >  **2D**.

The *Report* dialog box appears.

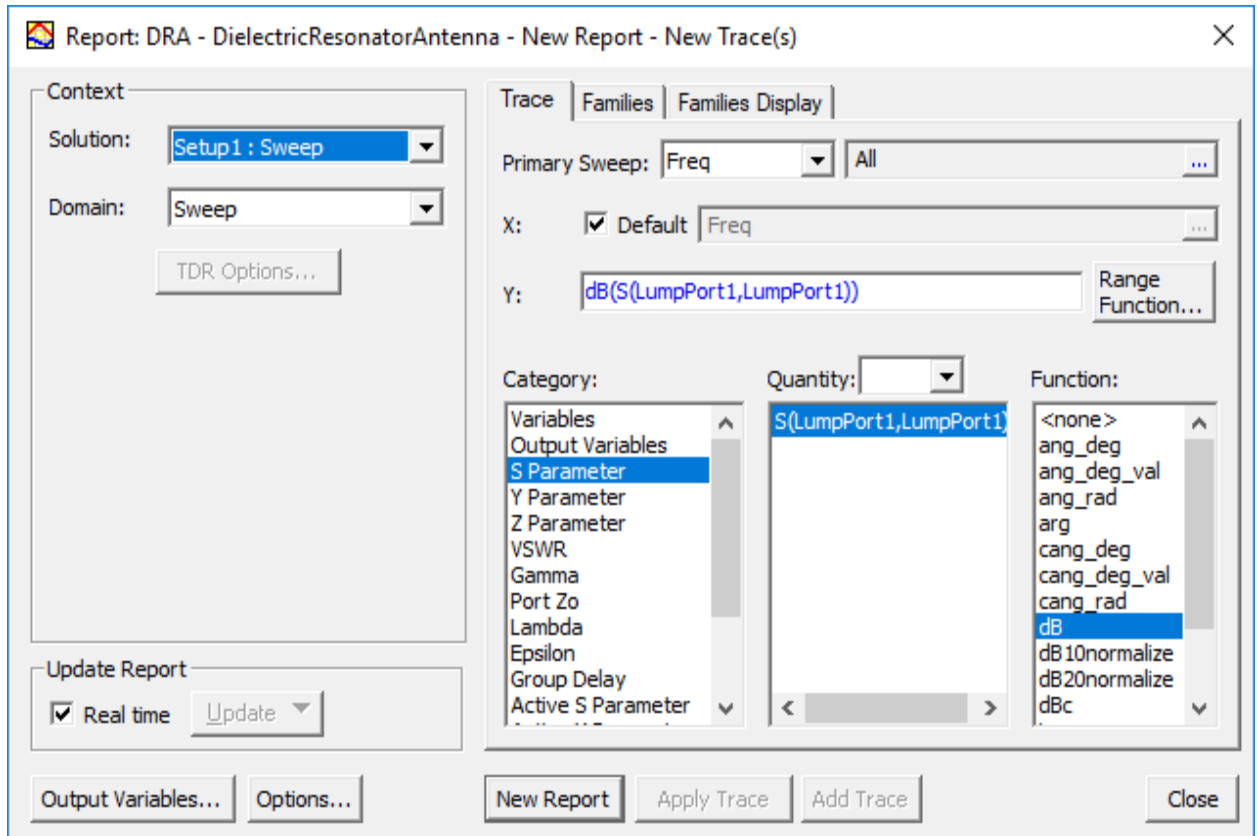

**Figure 6-1: Report Dialog Box – S Parameter Settings**

2. Verify that **Setup1 : Sweep** is selected from the **Solution** drop-down menu.
3. Verify that **Sweep** is selected from the **Domain** drop-down menu.
4. Verify that the **Default** option (*Freq*) is selected for the **X** axis.

The remaining settings control the plotted **Y** values:

5. Specify the following information to plot along the y-axis:

**Category**    **S Parameter**

This is the type of information to plot.

**Quantity**    **S(LumpPort1,LumpPort1)**

This is the value to plot.

**Function**    **dB**

This is the mathematical function of the quantity to plot.

6. In the **Families** tab, ensure that the **Sweeps** option is selected.

- Click **New Report** but leave the *Report* dialog box open. You will be adding another report in the next topic.

The **S Parameter Plot 1** report window appears and is listed under *Results* in the Project Manager. A trace icon with a description of the plotted Y value is also listed under *S Parameter Plot 1*. A trace is a single line that connects the related data points on the graph. A single graph can contain multiple traces.

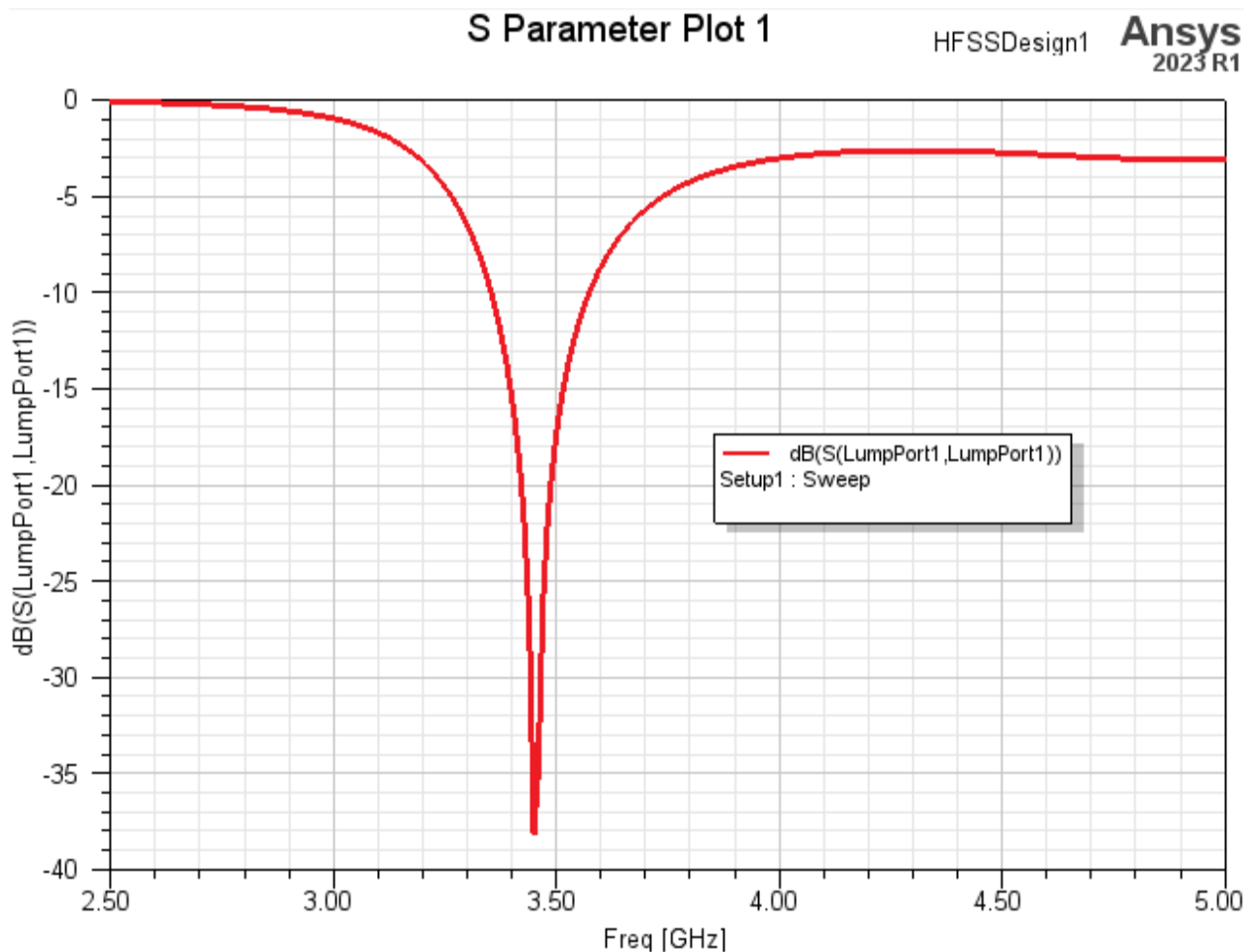

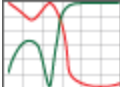

Figure 6-2: S Parameter Plot 1 – S(LumpPort1,LumpPort1), dB

## Create a Z-Parameters Report

The *Report* dialog box should still be open from the previous plot generation procedure. If you

accidentally closed it, click  **Modal Solution Data Report** >  **2D** on the **Results** ribbon tab. To generate a 2D report of Z(LumpPort1,LumpPort1) *Real* and *Imaginary* traces:

1. In the *Report* dialog box, select the **Trace** tab.

Leave the **Solution**, **Domain**, **Primary Sweep**, and **X** axis settings as defined for the previous plot.

2. In the **Y** axis settings, add the first of two traces to a new plot, as follows:
  - a. Specify the values from the table below for the *real* trace:

<b>Category</b>	<b>Z Parameter</b>
<b>Quantity</b>	<b>Z(LumpPort1,LumpPort1)</b>
<b>Function</b>	<b>re</b>

This is the real part of the complex number.

- b. Click **New Report**, but do *not* click *Close*.

The *Z Parameter Plot 1* report window appears with the *real* values plotted. The new plot and trace are also listed under *Results* in the Project Manager.

3. In the **Y** axis settings, add the second of two traces to the plot just created, as follows:
  - a. Specify the function from the table below for the *imaginary* trace. Leave all other settings as they are:

<b>Function</b>	<b>im</b>
-----------------	-----------

This is the imaginary part of the complex number.

- b. Click **Add Trace**.
- c. **Close** the *Report* dialog box.

The *imaginary* trace is added to *Z Parameter Plot 1* and is also listed under *Results* in the Project Manager.

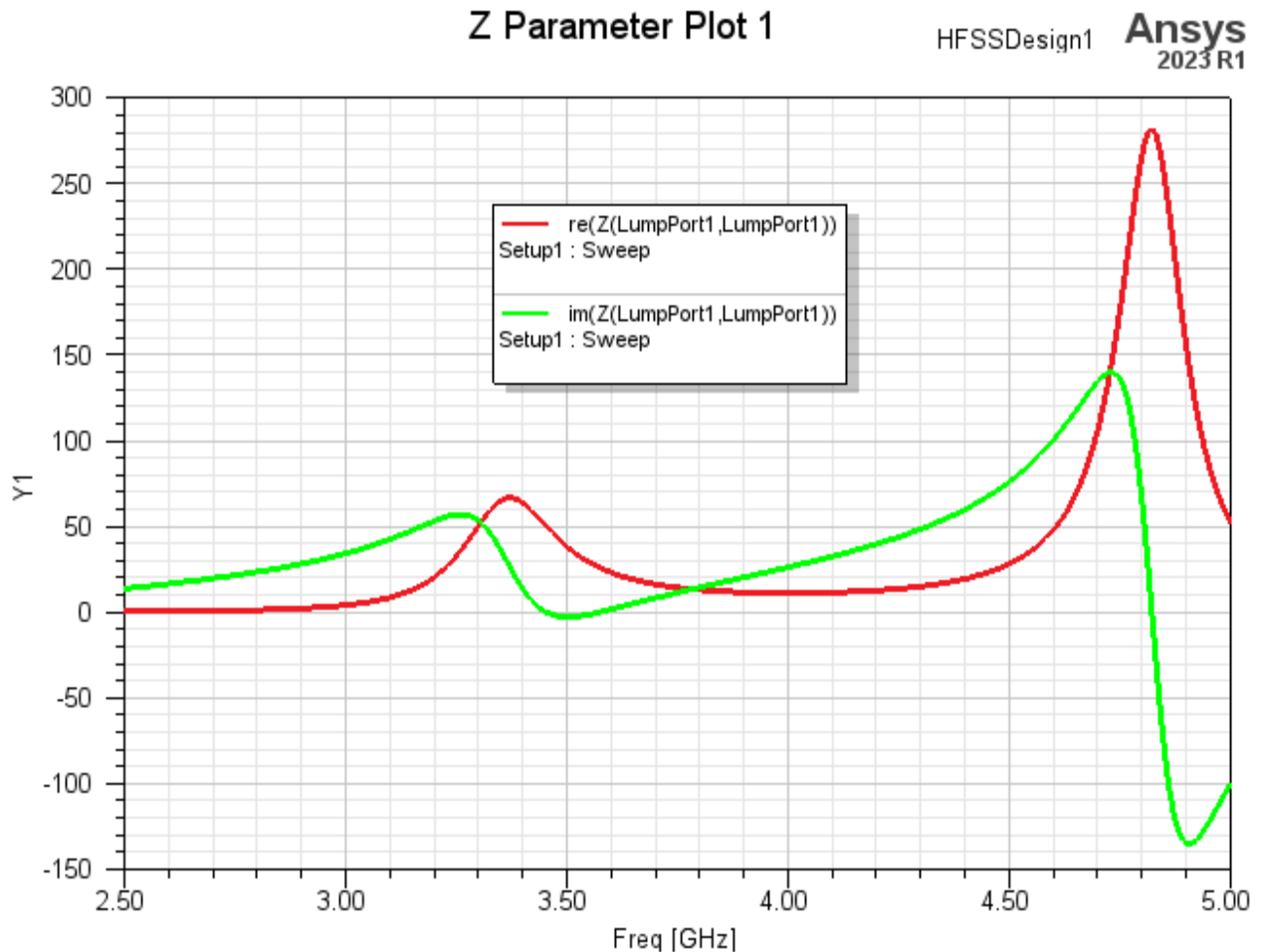

**Figure 6-3: Z Parameter Plot 1 –  $Z(\text{LumpPort1}, \text{LumpPort1})$ , Real and Imaginary Traces**

## Create a Mag E Field Overlay Plot

Now, you are ready to create and examine an E-field magnitude plot, overlaid on the bottom face of the air volume object.

1. Use the **Window** menu to return to the Modeler window.
2. On the **Draw** ribbon tab, click  **Grid** to toggle off the visibility of the drawing grid for a cleaner view of the fields overlay.
3. Click in the Modeler window background and press **F** to ensure that you're in the *Select Faces* mode.
4. Select the **bottom** face of the object **AirVolume**.

**Note:**

As previously demonstrated, this selection can be made without changing the model viewpoint. Click the cursor near the bottom of one of the rectangular facets, and then press **B** to select the face that is *Next Behind* the clicked point on the outer face.

- Right-click **Field Overlays** in the Project Manager and select **Plot Fields > E > Mag\_E** from the shortcut menu.

The *Create Field Plot* dialog box appears:

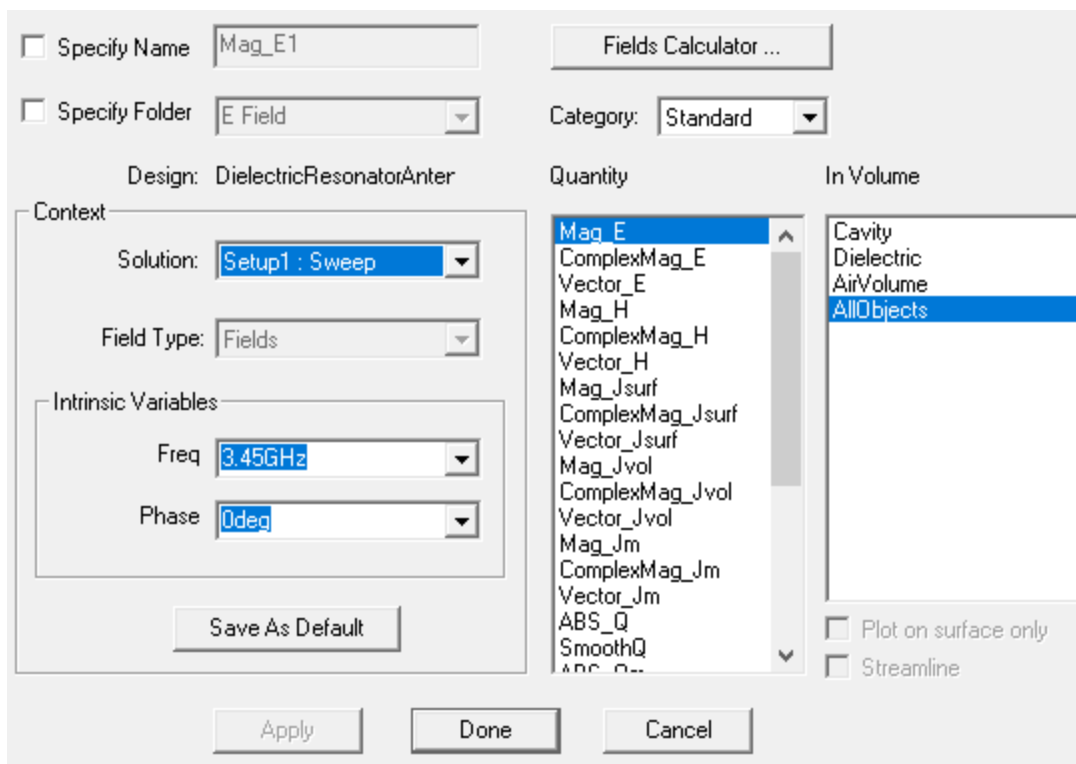

**Figure 6-4: Create Field Plot Dialog Box**

- From the **Solution** drop-down menu, select **Setip1 : Sweep**.
- From the **Freq** drop-down menu, select **3.45GHz**, which is the approximate frequency at which the minimum S-Parameter result occurs.

**Note:**

This drop-down menu includes a list of all frequencies for which a field solution is available. If *Setup1 : LastAdaptive* were selected as the *Solution* option, only the adaptive frequency of 3.5 GHz would be available in the *Freq* menu.

8. Verify that **0deg** is selected from the **Phase** drop-down menu.
9. Select **Mag\_E** from the **Quantity** list.

This result is the magnitude of the real part of the electric field  $\mathbf{E}(\mathbf{x},\mathbf{y},\mathbf{z},\mathbf{t})$ .

10. Select **AllObjects** from the **In Volume** list.

This option instructs HFSS to plot over the entire volume of the model.

11. Click **Done**.

The *Mag\_E1* field overlay cloud plot appears in the Modeler window and is now listed under *Field Overlays > E Field* in the Project Manager.

Your field overlay plot should resemble the one shown below:

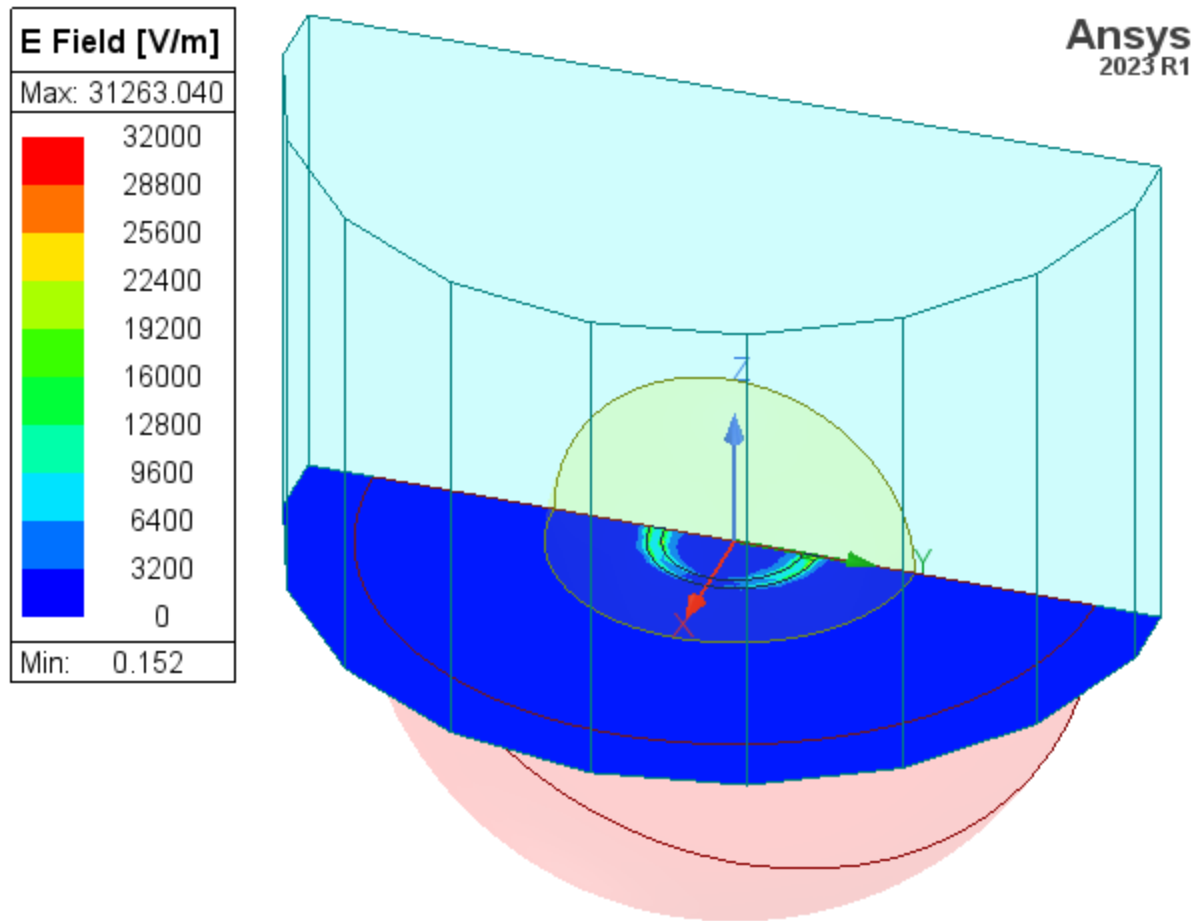

Figure 6-5: Initial *E Field* Overlay Plot

### Modify the Mag E Plot Attributes

Now, you will modify the attributes of the **Mag\_E1** field overlay plot you just created to prepare it for an effective animation.

1. Double-click within the **E Field [V/m]** plot legend rectangle.

A dialog box appears that has settings for the various plot and legend attributes.

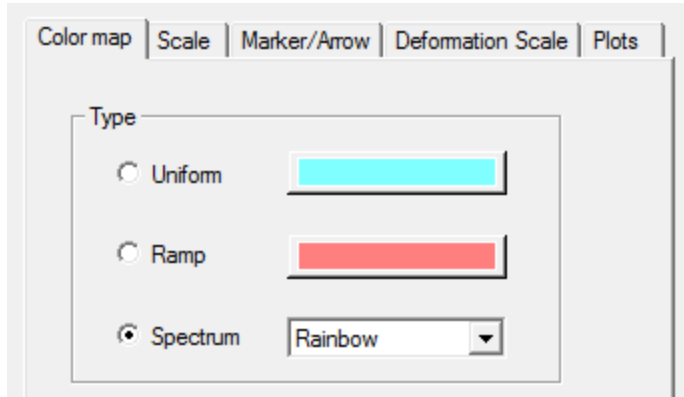

**Figure 6-6: [DRA] DielectricResonatorAntenna -- E Field Dialog Box**

2. In the **Color map** tab, specify the following settings:

<b>Type</b>	Select <b>Spectrum</b> and <b>Rainbow</b> from the pull-down list. Field quantities are plotted in multiple colors. Each field value is assigned a color from the selected spectrum.
<b>Real time mode</b>	Select this option, which immediately applies changes to the plot's attributes as you define them.

3. Select the **Scale** tab, and then specify the following settings:

<b>Use Limits</b>	Select this option. Only the field values between the minimum and maximum values will be plotted. Field values below or above these values will be plotted in the colors assigned to the minimum or maximum limits, respectively.
<b>Min</b>	Enter <b>3</b> .
<b>Max</b>	Enter <b>30000</b> .
<b>Linear/Log</b>	Select <b>Log</b> . Field values will be plotted on a logarithmic scale.
<b>Type</b>	Choose <b>Decimal</b> from the drop-down menu.
<b>Width</b>	Enter <b>10</b> .
<b>Precision</b>	Enter <b>2</b> .

4. Select the **Plots** tab, and then specify the following settings:

<b>IsoValType</b>	Select <b>Tone</b> from the pull-down list. This isosurface display type varies color continuously between iso-values.
<b>Outline</b>	Select this option to outline the color bands corresponding to the legend V/m increments.
<b>Map transp.</b>	Clear this option, if it is selected. If selected, the transparency of field values increases as the solution values decrease.

**Note:**

With *Real Time Mode* selected, most changes are applied immediately (as entered) and the **Apply** button is grayed out.

5. Accept all the remaining default settings in this dialog box and click **Close**.

Your modified plot **Mag\_E1** should resemble the one shown below:

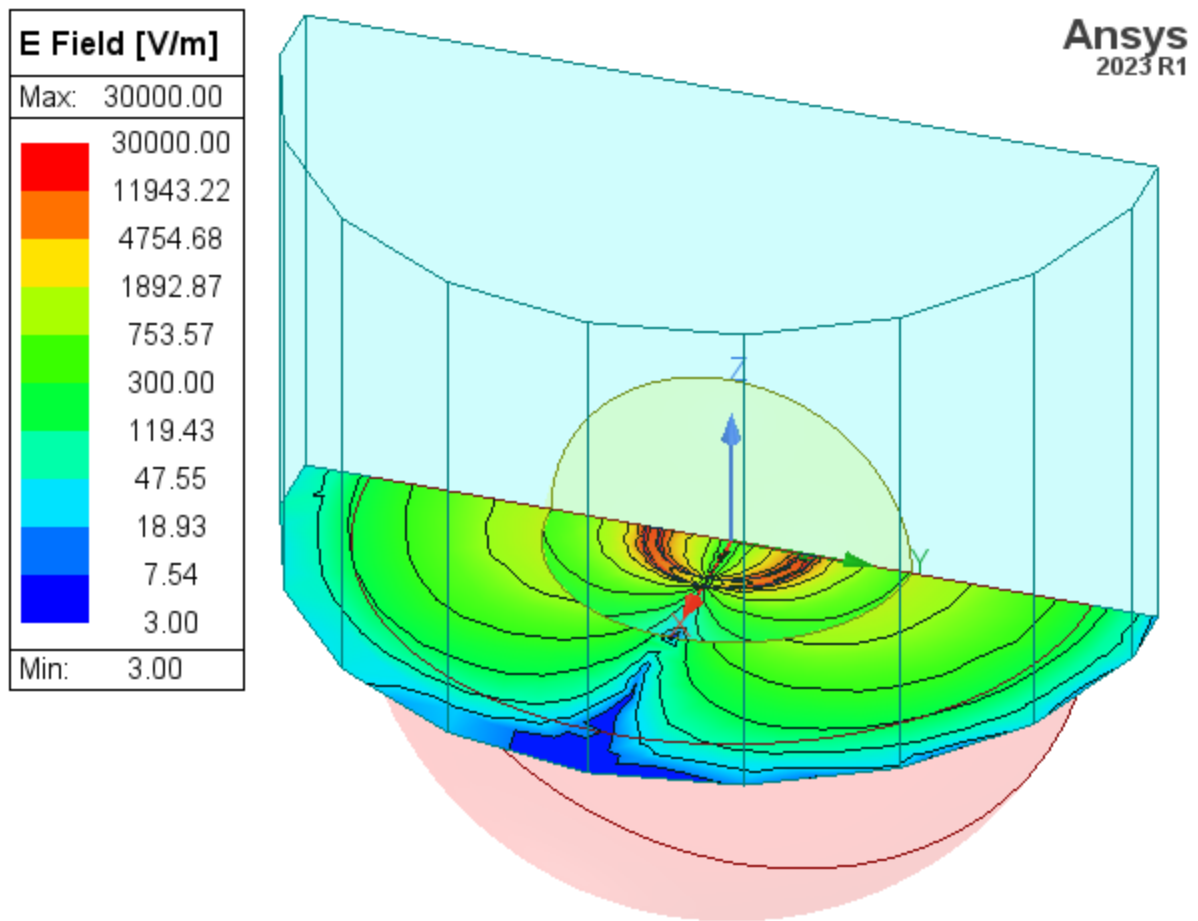

Figure 6-7: Modified *E Field* Plot Overlay

### Create a Phase Animation of the Mag E Plot

Next, you will create an animation of the field overlay plot of the magnitude of *E* to examine a frame-by-frame, animated behavior of the plot.

To create a phase animation of the Mag *E* plot:

1. Right-click **Mag\_E1** under *Field Overlays > E Field* in the Project Manager and click **Animate**.

The *Create Animation Setup* dialog box appears.

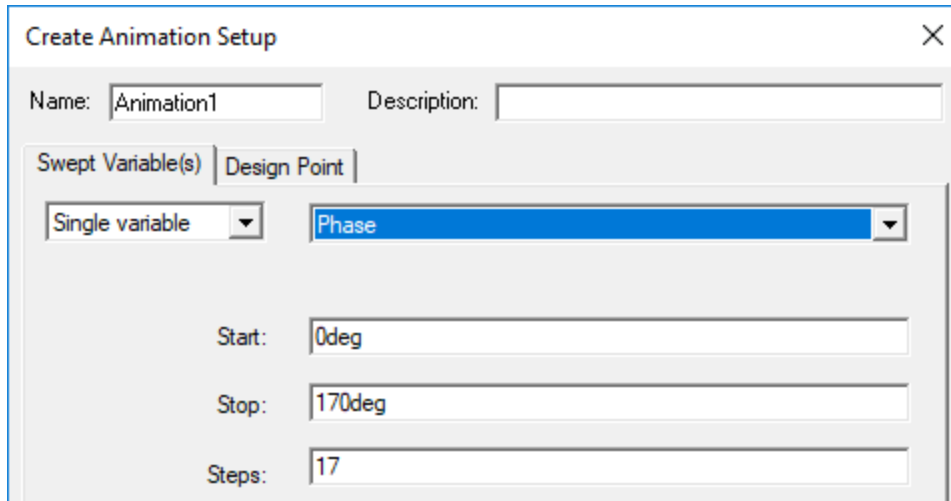

**Figure 6-8: Create Animation Setup Dialog Box**

2. Accept the default name **Animation1** in the **Name** text box.
3. Optionally, type a description of the animation in the **Description** text box. If you do not type a description, a default one will be added after you finish creating the animation.
4. Under the **Swept Variable** tab, ensure that **Single Variable** and **Phase** are selected from the two drop-down menus.
5. Accept the remaining default settings in the **Start**, **Stop**, and **Steps** text boxes for the phase values of the animation.

If the Start value is 0deg, the Stop value is 170deg, and the number of steps is 17, the animation will display the plot for 17 phase increments between 0 and 170. Therefore, the phase angle increment will be 10 degrees. The start value (0deg) will be the first frame displayed, and a total of 18 frames will comprise the animation.

6. Click **OK**.

The animation begins in the Modeler window. The play panel appears in the upper-left corner of the desktop, enabling you to stop, restart, and control the speed and sequence of the frames.

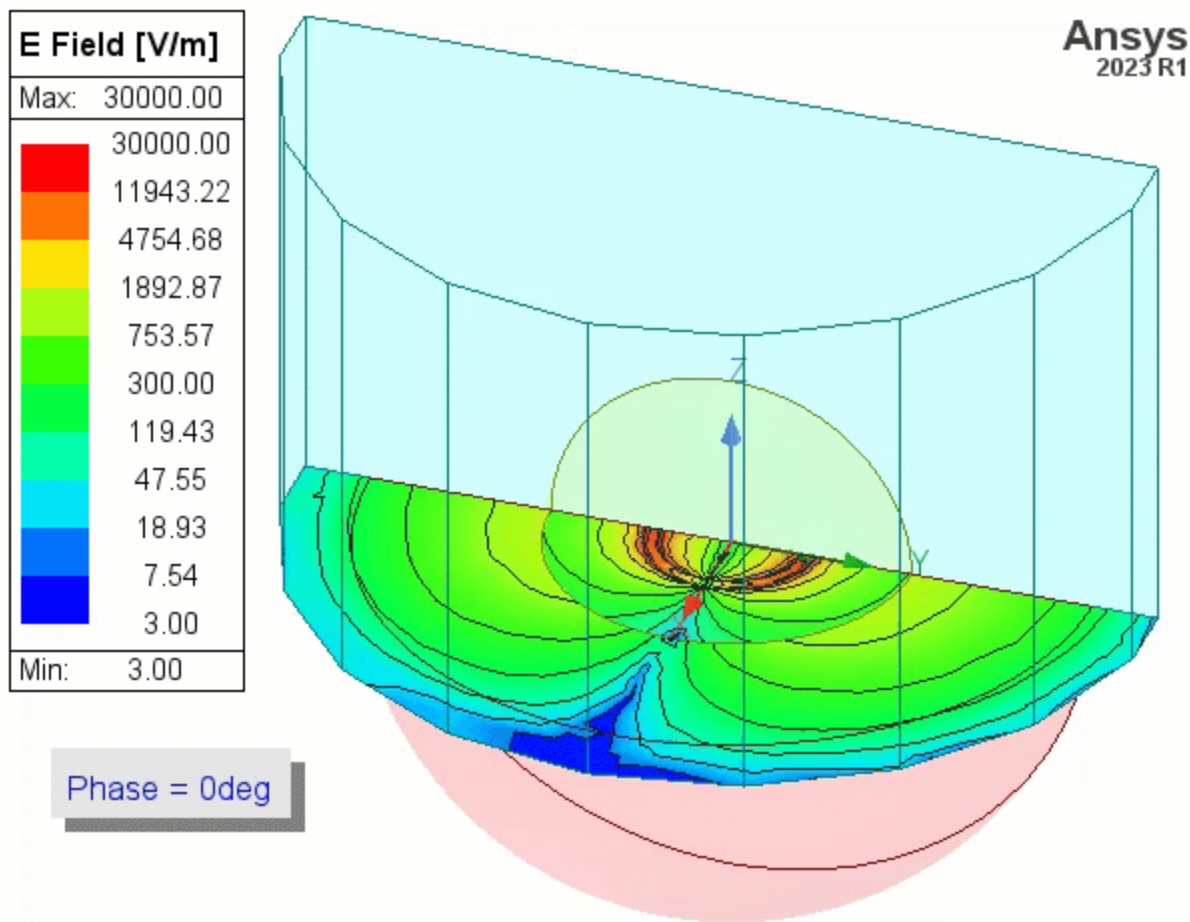

**Figure 6-9: E Field Animation**

7. Use the player controls to pause, restart, or reverse the animation and to adjust its playback speed.
8. Click **Close** when you're done viewing the animation.

# 7 - Optionally, Restore Current View Orientations

You have completed this getting started guide.

If you prefer to use the new view orientations implemented in version 2024 R1 of the Ansys Electronics Desktop application, clear the *Use Legacy View Orientation* option as follows:

1. From the menu bar, click **View > Options**.

The *3D UI Options* dialog box appears.

2. Ensure that **Enable Legacy View Orientation** is cleared:

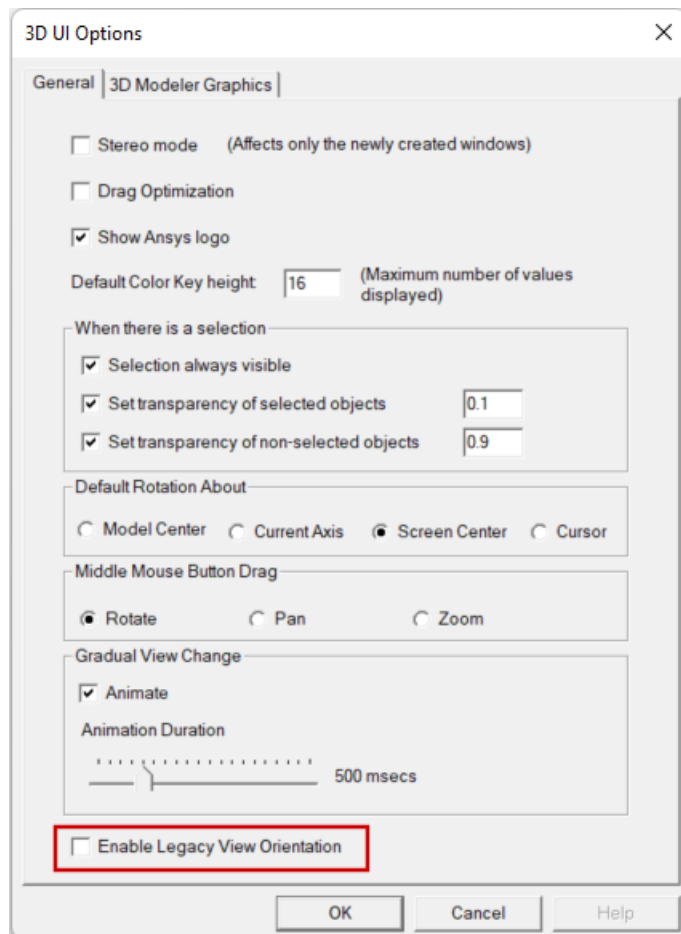

3. Click **OK**.

The settings in the 3D UI Options dialog box are global. Your choice is retained for all future program sessions, projects, and design types that use the 3D Modeler or that produce 3D plots of results.

You can now save and close this project.



# Index

---

.hfss file 2-1

## 3

3D Modeler window, defined 1-3

## A

adaptive solution 5-1

air volume 3-17

    assigning perfect E boundary  
    to 4-3

    assigning radiation boundary  
    to 4-2

animation

    creating a phase animation 7-1

animation, creating a phase anim-  
ation 6-11, 6-11

annular feed ring 3-11

annular feed ring, assigning perfect  
H boundary to 4-6

## B

boundaries

    about 4-1

    assigning a perfect E  
    boundary 4-3

    assigning a perfect H  
    boundary 4-6

    assigning a radiation  
    boundary 4-2

    assigning a symmetry boundary 4-7

    editing visualization settings of 4-2

    model-specific conditions 4-1

    solver view of 4-15

    verifying 4-15

## D

dialog boxes

    Create Field Plot 6-5

    Edit Sweep 5-3

    Element Length based refinement 5-6

    Lumped Port wizard 4-10

    Port Impedance Multiplier 4-14

    Setup Animation 6-11

    Solution Setup 5-1

    Split 3-1

    Symmetry Boundary 4-7

    Traces 6-1

drawing

    the air volume object 3-17

    the annular feed ring object 3-11

    the DRA object 3-9

    the feed gap object 3-15

## E

E-field

    animating 6-11

    plotting 6-5

elements, meshing 1-2

excitations

about 4-10

impedance multiplier 4-14

model-specific conditions 4-10

solver view of 4-15

verifying 4-15

## F

feed gap 3-15

feed gap, assigning lumped port  
to 4-10

field overlay plots

modifying attributes of 6-8

finite element method 1-2

frequency sweep

adding 5-3

defining the sweep 5-3

saving fields 5-3

## G

geometric model

assigning symmetry boundary  
to 4-7

fitting in drawing region 3-1

sample problem 1-1

solution parameters 5-1

splitting for symmetry 3-19

graphical user interface 1-3

## H

HFSS, interface overview 1-3

history tree, defined 1-3

## I

impedance multiplier

about 4-14

modifying 4-14

## L

lighting

ambient 3-6

disable attributes 3-6

distant 3-6

lumped port 4-10

lumped ports

impedance multiplier 4-14

## M

mag E

field overlay plots of 6-5

plotting 6-5

menu bar, defined 1-3

mesh

defining mesh operations 5-5

elements 1-3

example of 1-2, 1-2

refining 5-5

seeding 5-5

mesh operations 5-5

restricting length 5-5

Message Manager window,  
defined 1-3

## O

objects

- air volume 3-17
- annular feed ring 3-11
- assigning lumped ports to 4-10
- feed gap 3-15
- splitting 3-1
- splitting for symmetry 3-19

## P

perfect E boundary

- assigning 4-3
- defined 4-1

perfect H boundary

- assigning 4-6
- defined 4-1

plots

- animating 6-11, 6-11, 7-1
- appearance in the project tree 6-1, 6-3
- creating a cloud plot 6-5
- creating a mag E plot 6-5
- modifying attributes of 6-8

profile data 5-9

Progress window

- defined 1-3
- displaying solution progress 5-7

project

- creating 2-1
- saving 2-1
- validating 5-6, 5-6

Project Manager 2-2

Project Manager window, defined 1-3

project tree, introduction 2-1

Properties window, defined 1-3

## R

radiation boundary

- assigning 4-2
- defined 4-1

reports

- animating 6-11, 7-1, 7-1
- appearance in the project tree 6-1, 6-3
- creating a cloud plot 6-5
- creating S11 6-1
- creating Z11 6-3
- generating 2D graphs 6-1

results

- evaluating 6-1

## S

S11, creating report of 6-1

simulation, running 5-7

solution

- adding a fast frequency sweep 5-3
- defining mesh operations 5-5

results 6-1

viewing convergence data 5-11

viewing matrix data 5-12, 5-14

viewing profile data 5-9

solutions

adaptive 5-1

adaptive analysis 5-7

and setting parameters 5-1

frequency 5-1

setting solution parameters 5-1

status bar, defined 1-3

symmetry boundary

defined 4-1

## **T**

toolbars, defined 1-3

## **V**

validation check 5-6

## **W**

wave ports, impedance multiplier 4-14

## **Z**

Z11, creating report of 6-3